



## DOCK & LIFT

BUMPERS &  
ACCESSORIES

*Finding the Right Parts  
Has Never Been Easier*

**SUPERIOR QUALITY**

**LARGE SELECTION**



[www.glmarineproducts.com](http://www.glmarineproducts.com)





Since 1971, dock and watercraft owners have trusted the quality and workmanship of Great Lakes Marine Products. We are a second-generation family-owned business located in a small town of 1,100. We take great pride in our products and service we provide and strive to manufacture most of our items onsite and continue the tradition of quality made in the USA.

**800-541-9860**  
**[glmarineproducts.com](http://glmarineproducts.com)**



# INDEX

- 2** Corner Bumpers
- 4** Dock Wheels
- 5** Torpedo Bumpers
- 6** Adjustable Side Bumpers
- 8** Rectangular Bumpers
- 9** Edging Bumpers
- 12** Rub Rails
- 14** Post Caps, Cover and Plugs
- 16** Dock Cleats
- 18** Solar Lights
- 19** Anchors & Tie Downs
- 20** Storage Boxes & Coolers
- 21** Roll-in Wheels
- 22** Dock Ladders
- 24** Steps & Stairs
- 26** Seating & Umbrellas
- 28** Dock Bracing & Augers
- 30** Winches
- 32** Kayaks & Accessories
- 34** SLX Wave Port
- 36** Apex Wave Port
- 38** Genesis & Extreme
- 40** Wave Dock
- 41** Wave Dock Accessories
- 44** Otter Island Raft
- 45** Otter Island Accessories
- 46** Dock Gates & Mat Rack
- 47** Bunk Treads & Carpet
- 48** Centering Guides
- 49** Lift Accessories
- 50** Electric Hoists
- 51** Solar Panels & Battery Stands
- 52** Dock Floats
- 55** Dock Hardware
- 60** Piling Rings & Caps
- 62** Camper Stabilizers
- 64** ATV Trailer & Boxes
- 66** Replacement Parts for Basta Hydraulic Lift
- 68** Replacement Parts for Shore Mate Hydraulic Lift
- 69** Replacement Parts for RGC Hydraulic Lift
- 70** Replacement Parts for Sunstream Hydraulic Lift
- 74** Canopy Repair & Storage
- 76** Replacement Boatlift Covers for:
  - Allen Dock
  - Aqua Lift
  - Craftlander
  - Daka
  - Demco
  - Dock Rite
  - Dock Rite of Canada
  - Dockside
  - Feighner
  - Floe
  - Great Lakes
  - Harbor Master
  - Hewitt
  - Lakeshore
  - Midlander
  - Newman
  - Nyman
  - Pier Pleasure
  - Porta Dock
  - RGC
  - Sealegs
  - Shoremate
  - Shore Master
  - Shore Station
  - Sunstream
  - Triton
  - Vibo



*Items must be ordered from your Great Lakes Marine Products dealer.  
All items in this publication are subject to change without notice.*



# CORNER BUMPERS

Our corner bumpers are made to protect your water vehicles from the most unforgiving part of the dock. The sculpted sides and nose provide an attractive finish with plenty of surface area for easy mounting. They are rotationally molded for long-lasting quality.

## 6" UNIVERSAL CORNER BUMPER

Marine-grade PVC with one-inch solid outside flange for fastening to dock.

Colors: White, Black, Light Gray, Dark Gray, Blue

- White **part# D1BUC6WE**
- Black **part# D1BUC6BK**
- Blue **part# D1BUC6BE**
- Light Gray **part# D1BUC6GYL**
- Dark Gray **part# D1BUC6GYD**

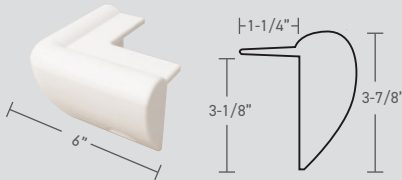

Volume Pack 16 pcs  
(5 fasteners recommended per bumper, see page 3.)

## 10" UNIVERSAL CORNER BUMPER

Marine-grade PVC with one-inch solid outside flange for fastening to dock.

Colors: White, Black, Blue, Light Gray, Dark Gray

- White **part# D1BUC10WE**
- Black **part# D1BUC10BK**
- Blue **part# D1BUC10BE**
- Light Gray **part# D1BUC10GYL**
- Dark Gray **part# D1BUC10GYD**

Volume Pack 12 pcs.  
(7 fasteners recommended per bumper, see page 3.)

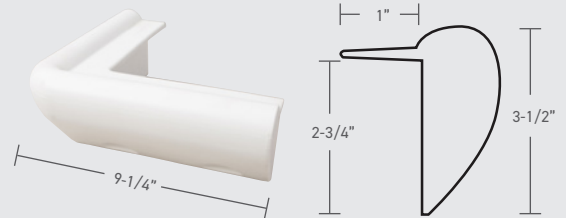

## 10" CLASSIC CORNER BUMPER

Marine-grade PVC with one-inch solid outside flange for fastening to dock.

Colors: White, Black, Blue, Tan, Light Gray, Dark Gray, Khaki

- White **part# D1BUCWE**
- Black **part# D1BUCBK**
- Blue **part# D1BUCBE**
- Tan **part# D1BUCTN**
- Light Gray **part# D1BUCGYL**
- Dark Gray **part# D1BUCGYD**
- Khaki **part# D1BUCKI**

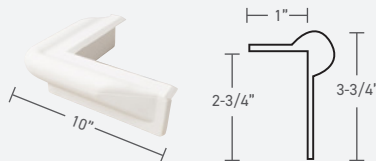

Volume Pack 12 pcs  
(7 fasteners recommended per bumper, see page 3.)

## TRUSS CORNER BUMPER

Designed to work with truss docks with up to a 11.5" span. Marine-grade PVC.

Colors: White, Black, Blue, Tan, Green, Light Gray, Dark Gray, Chocolate, Khaki

- 8"
- White **part# D1BUTC8WE**
  - Black **part# D1BUTC8BK**
  - Blue **part# D1BUTC8BE**
  - Tan **part# D1BUTC8TN**
  - Green **part# D1BUTC8GN**
  - Light Gray **part# D1BUTC8GYL**
  - Dark Gray **part# D1BUTC8GYD**
  - Chocolate **part# D1BUTC8CE**
  - Khaki **part# D1BUTC8KI**

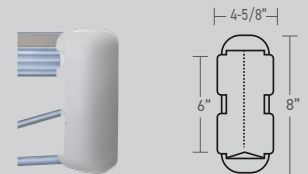

- 11"
- White **part# D1BUTC11WE**
  - Black **part# D1BUTC11BK**
  - Blue **part# D1BUTC11BE**
  - Tan **part# D1BUTC11TN**
  - Green **part# D1BUTC11GN**
  - Light Gray **part# D1BUTC11GYL\***
  - Dark Gray **part# D1BUTC11GYD**
  - Chocolate **part# D1BUTC11CE**
  - Khaki **part# D1BUTC11KI\***

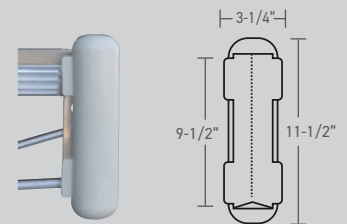

- 13"
- White **part# D1BUTC13WE\***
  - Black **part# D1BUTC13BK**
  - Blue **part# D1BUTC13BE**
  - Tan **part# D1BUTC13TN\***
  - Green **part# D1BUTC13GN**
  - Light Gray **part# D1BUTC13GYL\***
  - Dark Gray **part# D1BUTC13GYD**
  - Chocolate **part# D1BUTC13CE**

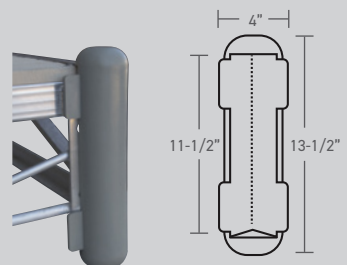

\*Style like 8" bumper  
Volume Pack 12 pcs (4 fasteners recommended per bumper, see page 3.)

## 10" SMALL LIP CORNER BUMPER

Marine-grade PVC with small 3/16" flange for fastening to dock.

Colors: White, Black, Blue, Tan, Light Gray, Dark Gray

- White **part# D1BUCSLWE**
- Black **part# D1BUCSLBK**
- Blue **part# D1BUCSLBE**
- Tan **part# D1BUCSLTN**
- Light Gray **part# D1BUCSLGYL**
- Dark Gray **part# D1BUCSLGYD**

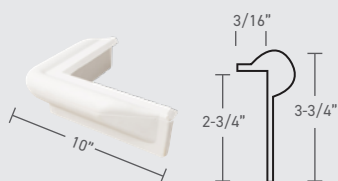

Volume Pack 12 pcs  
(7 fasteners recommended per bumper, see page 3.)



**BUMPER COLORS**

White

Black

Blue

Green

Tan

Light Gray

Dark Gray

Chocolate

Red

Khaki

Teal

*Material: Marine-grade PVC. This formulation is designed to be both soft and strong. It provides great cushioning under impact and will always return to the original form. It is made for a long life with UV and antifungal protection and will not fade, tear or become waterlogged.*

**LOWER LIP CORNER BUMPER**

Wraps around 4.5" docks. One-inch solid outside flange for fastening to dock. Marine-grade PVC.

Colors: White, Black, Blue, Light Gray

White **part# D1BLLCWE**  
 Black **part# D1BLLCBK**  
 Blue **part# D1BLLCBE**  
 Light Gray **part# D1BLLCGYL**

Volume Pack 12 pcs  
 (7 fasteners recommended per bumper, see page 3.)

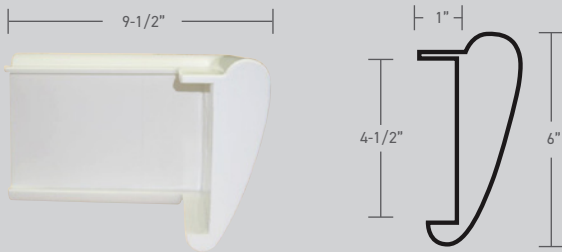

**24" POLY HARBOR CUSHION CORNER**

Made of tough and durable polyethylene.

White **part# D1BPHCW**  
 Black **part# D1BPHCB**

Volume Pack 6 pcs

(Requires 4 bolts, 4 nuts and 8 washers per bumper)

3/8" x 3" SS Hex Bolt **part# NB383G**  
 Used with wall thickness up to 1"

3/8" x 4" SS Hex Bolt **part# NB384G**  
 Used with wall thickness up to 2"

3/8" Brass Nut **part# NN38S**

3/8" SS Flat Washer **part# NW38FL**

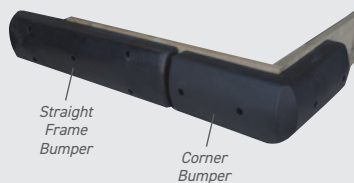
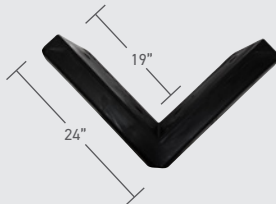
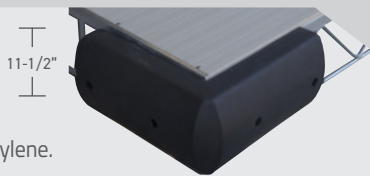

Matching 48" bumper on page 11.

**POLY BUMPER BACKING PLATE**

3/8" x 2" Aluminum.

**part # D1BPHCP**  
 Volume Pack 100 pcs



**12" SOFT HARBOR CORNER BUMPER**

Designed for larger docks and watercraft. Flat ends can be mounted together with harbor straight bumper. Marine-grade PVC.

Colors: White, Black, Light Gray

White **part# D1BHCWE**  
 Black **part# D1BHCBK**  
 Light Gray **part# D1BHCGYL**

Volume Pack 6 pcs  
 (8 fasteners recommended per bumper, see page 3.)

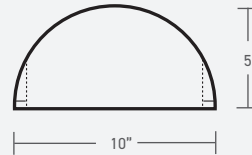

Matching 36" bumper on page 9.



**6A CORNER BUMPER & 6B SIDE BUMPER**

6A Corner and 6B Side Bumper, Polyethylene bumper available in black only.

Corner **part# D1B6A**  
 Side **part# D1B6B**

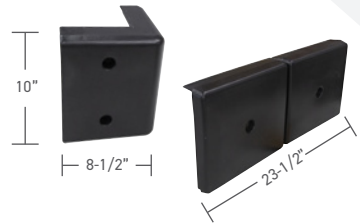

**BUMPER SCREWS - SELF-TAPPING**

High-quality 1" screws fasten bumper to your dock frame with a large .455" head. Ideal for aluminum and composite decking and aluminum frames. 50 qty bag (self-tapping)

**part# D1BUSC** Volume Pack 12 pcs

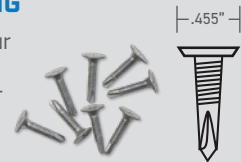

**BUMPER SCREWS - WOOD**

#10 Stainless steel 1-1/4" bumper screws for wood decking/docks. 50 qty bag

**part# D1BUSCSS** Volume Pack 12 pcs

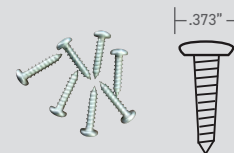

**LAG BOLT SET**

Galvanized lag bolts for attaching harbor and frame bumpers to wood docks.

3/8" x 2" galvanized lag bolt **part# NB382L**  
 3/8" x 3" galvanized lag bolt **part# NB383L**  
 3/8" x 5" galvanized lag bolt **part# NB385L**  
 3/8" SS flat washer **part# NW38FL**





# DOCK WHEELS

## 12" WHEEL - POST MOUNT

These dock wheels are designed to gently roll your watercraft along the dock. They will fit over 1-1/4", 1-1/2", or 2" dock pipe with an optional locking collar.

Material: Marine-grade PVC

Installation: Slide one nylon bushing over post and tighten set screws. Slide the dock wheel over the post, then slide second nylon bushing over post and tighten set screws.

Color: White Volume Pack 6 pcs

For 1-1/4" and 1-1/2" Pipe Wheel Only **part# DF300021**

For 2" Pipe Wheel Only **part# DF301032**

Locking Collar **part# D1BDW12COLLAR**  
Nylon bushing with nylon set screws for easy height adjustment and locking wheel from being raised.

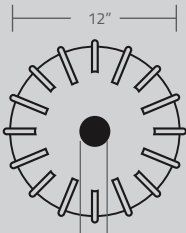

1-1/4" and 1-1/2" have 2" opening  
2" has 2-1/2" opening

## 10" & 14" WHEEL - CORNER MOUNT

These dock wheels are designed to gently roll your watercraft along the dock. Attaches to corners of dock.

Material: Marine-grade PVC

Color: White

10" Corner Roller **part# D1CR10**  
14" Corner Roller **part# D1CR14**



**BUMPER COLORS**

White Black Blue Green

Tan Light Gray Dark Gray Chocolate Red Khaki Teal

# TORPEDO BUMPERS

*Eliminate rubbing damage. Marine-grade vinyl bumpers slide easily over dock pipe.*

## TORPEDO POST BUMPER

Slides over dock pipe and wraps around support stand bracket. Protects your boat from rubbing on dock.

Marine-grade PVC vinyl with UV and anti-fungal protection.

Installation: Slide the top end cap down the length of your dock post, then open the slit on the bottom end cap and wrap the cap around the post under your dock while fitting the dock hardware in the recessed back.

Colors: White, Black, Blue, Green, Tan, Light Gray, Dark Gray, Chocolate, Cranberry, Khaki, Teal

Volume Pack 12 pcs

### 18" Torpedo Post Bumper

- White **part# D1BT18WE**
- Black **part# D1BT18BK**
- Blue **part# D1BT18BE**
- Green **part# D1BT18GN**
- Tan **part# D1BT18TN**
- Light Gray **part# D1BT18GYL**
- Dark Gray **part# D1BT18GYD**
- Chocolate **part# D1BT18CE**
- Khaki **part# D1BT18KI**
- Teal **part# D1BT18TL**

### 24" Torpedo Post Bumper

- White\* **part# D1BT24WE**
- Black **part# D1BT24BK**
- Blue\* **part# D1BT24BE**
- Green **part# D1BT24GN**
- Tan **part# D1BT24TN**
- Light Gray **part# D1BT24GYL**
- Dark Gray **part# D1BT24GYD**
- Khaki **part# D1BT24KI**

\* Best Sellers

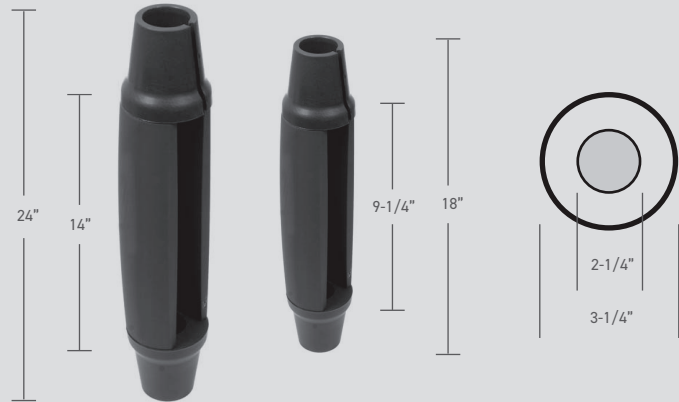



# ADJUSTABLE SIDE BUMPERS

These bumpers are specially designed to work with modern truss-style docking. The bumpers have an aluminum extrusion inside the bumper with a rail exposed on the back side. The rail holds the bolt heads that can slide up or down the bumper to adjust the height before the hardware is tightened.

Installation: Simply place the bumper in the desired location and attach the back plate and nuts.

Material: Marine-grade PVC, Aluminum core

## 30" HALF-ROUND BUMPER WITH ALUMINUM BACKER - VERTICAL

Colors: White, Black, Blue, Light Gray, Chocolate, Green, Tan, Khaki

White	part# D1BU30VWE
Black	part# D1BU30VBK
Blue	part# D1BU30VBE
Light Gray	part# D1BU30VGYL
Chocolate	part# D1BU30VCE
Green	part# D1BU30VGN
Tan	part# D1BU30VTN
Khaki	part# D1BU30VKI

Volume Pack 12pcs



## 30" HALF-ROUND BUMPER WITH ALUMINUM BACKER - HORIZONTAL

Colors: White, Black, Blue, Light Gray, Chocolate, Green, Tan, Khaki

White	part# D1BU30HWE
Black	part# D1BU30HBK
Blue	part# D1BU30HBE
Light Gray	part# D1BU30HGYL
Chocolate	part# D1BU30HCE
Green	part# D1BU30HGN
Tan	part# D1BU30HTN
Khaki	part# D1BU30HKI

Volume Pack 12pcs

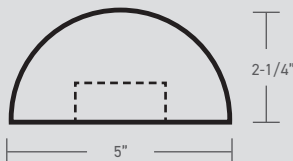
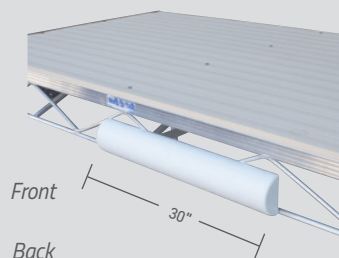

## 36" BUMPER WITH ALUMINUM BACKER

Low density polyethylene.

Installation: Simply place the bumper in the desired location and attach the back plate and nuts.

Colors: White, Black

2" Deep	
White	part# D1BU36WA2W
Black	part# D1BU36WA2B

3-1/2" Deep	
White	part# D1BU36WAXW
Black	part# D1BU36WAXB

Volume Pack 14pcs

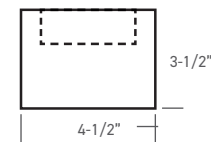
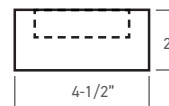
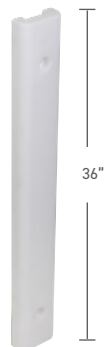

Front

Back

*It is recommended that the rub rail of your boat comes in contact with the bumper rather than the bumper to come in contact with the sides of your boat as this can result in serious damage to the sides of your boat.*

**Durable plastic bumper mounted on a 2" x 2" aluminum tube with your choice of aluminum mounting hardware. This setup is completely adjustable.**

**WAVE DOCK MOUNT**

**part# D1BUVW**  
Volume Pack 12pcs



**LARGE PIPE MOUNT**

**part# D1BUVL**  
Volume Pack 12pcs

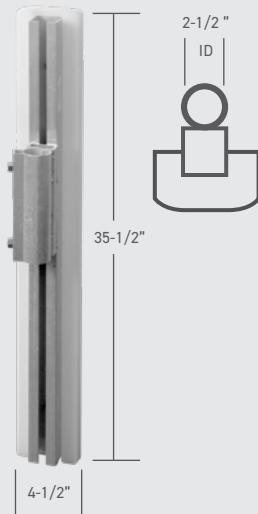

**PIPE MOUNT**

**part# D1BUVP**  
Volume Pack 12pcs

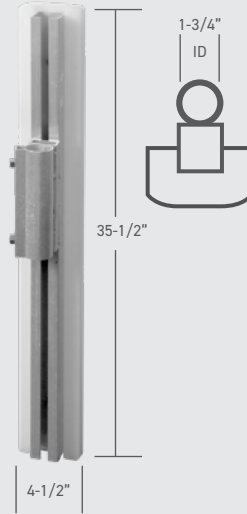

**ULTRA BRACKET**

**part# D1BUVDU1**  
Volume Pack 12pcs



*Must also purchase side-mount bumper.*

**part# D1BUVS**  
Volume Pack 12pcs

**DECK MOUNT**

**part# D1BUVD**  
Volume Pack 12pcs



**SIDE MOUNT**

**part# D1BUVS**  
Volume Pack 12pcs



**SECTIONAL MOUNT**

**part# D1BUVV**  
Volume Pack 12pcs

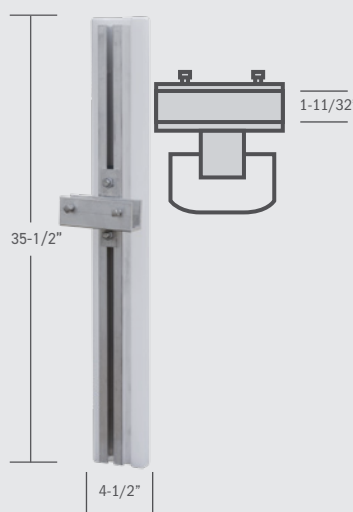

**LOCKING ARM BUMPER**

Use as a bumper or centering guide. Simply slide over square post. Volume Pack 12pcs

White **part# D1BUVAW**  
Black **part# D1BUVAB**

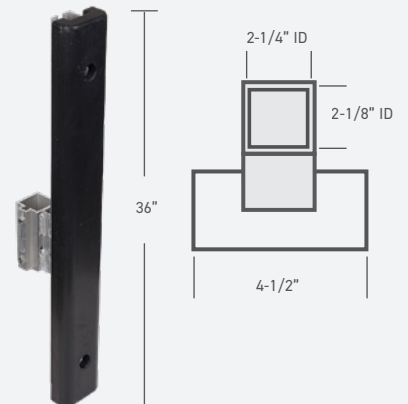



# RECTANGULAR BUMPERS

BUMPER COLORS

White

Black

Blue

Green

*Our bumpers offer superior cushioning under impact and will always return to original form.*

## 36" PIPE CUSHION

Durable, long-lasting protection. Will not scratch or mark your boat. Environmentally safe and recyclable. Can easily be mounted to any dock system to provide maximum protection for your boat and dock. This cushion is made of tough and durable polyethylene with ultra-violet inhibitors. Safe for both fresh and salt water. Mount vertically on poles and pilings. UV and antifungal protection.

Volume Pack 12 pcs

Color: White

1-5/8" post  
part# D1BPC158

2-3/8" post  
part# D1BPC238

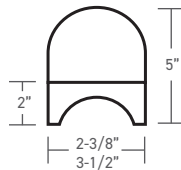
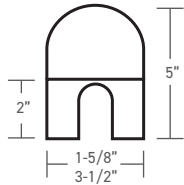
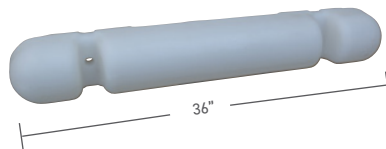

## STRAIGHT BUMPER

Marine-grade PVC. Mount on the sides of any wood or metal dock.

Colors: White, Black, Blue, Tan, Light Gray, Dark Gray, Khaki

White part# D1BUSWE  
Black part# D1BUSBK  
Blue part# D1BUSBE  
Tan part# D1BUSTN  
Light Gray part# D1BUSGYL  
Dark Gray part# D1BUSGYD  
Khaki part# D1BUSKI



Volume Pack 12 pcs

(6 fasteners recommended per bumper, see page 3.)

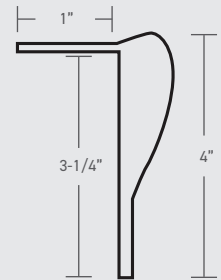

## 36" AND 48" ROUND EDGE GUARD

Handles larger watercraft. Marine-grade PVC with UV and anti-fungal protection.

Colors: White, Black, Blue, Green, Tan, Light Gray, Khaki

Volume Pack 12 pcs

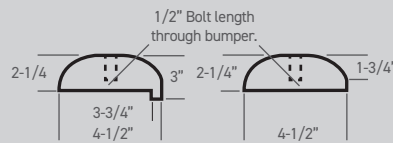
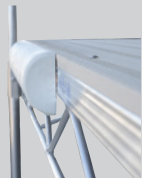

**48" Without Lip**  
White part# D1BUE48WE  
Black part# D1BUE48BK

(Requires 4 bolts, 4 nuts and 8 washers per bumper)

3/8" x 3" SS Hex Bolt part# NB383G

used with wall thickness up to 1"

3/8" x 4" SS Hex Bolt part# NB384G

used with wall thickness up to 2"

3/8" Brass Nut part# NN38S

3/8" SS Flat Washer part# NW38FL

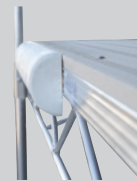
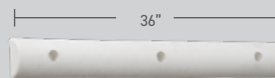

### 36" Without Lip

White part# D1BUEWE  
Black part# D1BUEBK  
Blue part# D1BUEBE  
Green part# D1BUEGN  
Tan part# D1BUETN  
Light Gray part# D1BUEGYL  
Khaki part# D1BUEKI



### 36" With Lip

White part# D1BUELWE  
Black part# D1BUELBK  
Blue part# D1BUELBE  
Green part# D1BUELGN  
Tan part# D1BUELTN  
Light Gray part# D1BUELGYL  
Khaki part# D1BUELKI

(Requires 3 bolts, 3 nuts and 6 washers per bumper)

3/8" x 3" SS Hex Bolt part# NB383G

used with wall thickness up to 1"

3/8" x 4" SS Hex Bolt part# NB384G

used with wall thickness up to 2"

3/8" Brass Nut part# NN38S

3/8" SS Flat Washer part# NW38FL

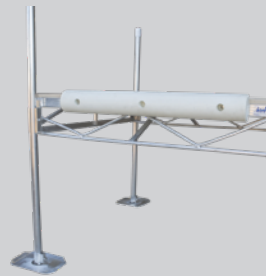

# EDGING BUMPERS

## 36" SOFT HARBOR BUMPER

Handles larger watercraft. 5" of projection from the dock. Marine-grade PVC.

Colors: White, Black, Light Gray

- White **part# D1BHSWE**
- Black **part# D1BHSBK**
- Light Gray **part# D1BHSGYL**

Volume Pack 12 pcs  
(8 fasteners recommended per bumper, see page 3.)

Matching corner on page 5.

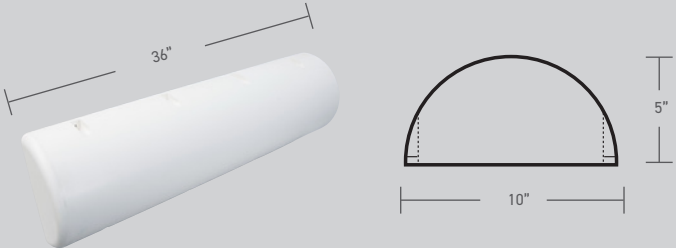
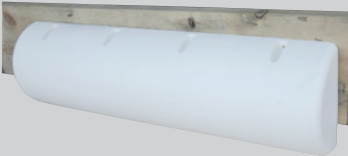

## DOCKSIDE BUMPER

Larger-sized bumper with deep projection with nautical design. Marine-grade PVC.

Colors: White, Black, Blue, Green, Tan, Light Gray, Khaki

- White **part# D1BDBWE**
- Black **part# D1BDBBK**
- Blue **part# D1BDBBE**
- Green **part# D1BDBGN**
- Tan **part# D1BDBTN**
- Light Gray **part# D1BDBGYL**
- Khaki **part# D1BDBKI**



Volume Pack 12 pcs  
(4 fasteners recommended per bumper, see page 3.)





# EDGING BUMPERS

## 24" AND 36" PLASTIC BUMPERS

High-strength polyethylene plastic formulated with UV protection for the marine environment. Mount to square poles with recessed mounting holes.

Colors: White, Black, Green, Tan, Light Gray  
Volume Pack 12 pcs

### 24" Bumpers

Flat back-White  
2" slot-White  
2" slot-Black  
3-1/2" slot-White  
3-1/2" slot-Black  
3-1/2" slot-Light Gray

part# D1BUVP24FW  
part# D1BUVP24W  
part# D1BUVP24B  
part# D1BUVP243W  
part# D1BUVP243B  
part# D1BUVP243GYL

### 36" Bumpers

2" slot-White  
2" slot-Black  
2" slot-Green  
2" slot-Tan  
2" slot-Light Gray  
(Mounted to 2x2 tube. Requires 2 bolts, 2 nuts and 4 washers per bumper)  
3/8" x 3-1/2" SS Hex Bolt  
used with tube thickness up to 2"  
3/8" Brass Nut  
3/8" SS Flat Washer

part# D1BUVP2W  
part# D1BUVP2B  
part# D1BUVP2G  
part# D1BUVP2TN  
part# D1BUVP2GYL

### 36" Bumpers

3-1/2" slot-White  
3-1/2" slot-Black  
(Mounted to 3x3 tube. Requires 2 bolts, 2 nuts and 4 washers per bumper)  
3/8" x 4-1/2" SS Hex Bolt  
used with tube thickness up to 3"  
3/8" Brass Nut  
3/8" SS Flat Washer

part# D1BUVP3W  
part# D1BUVP3B

part# NB38412G

part# NN38S  
part# NW38FL

### X36" Bumpers

X36" Plastic with 3-1/2" Slot-White  
X36" Plastic with 3-1/2" Slot-Black  
(Mounted to 3x3 tube. Requires 2 bolts, 2 nuts and 4 washers per bumper)  
3/8" x 6" Bolt  
used with tube thickness up to 3"  
3/8" Brass Nut  
3/8" SS Flat Washer

part# D1BUVP312W  
part# D1BUVP312B

part# NB386G

part# NN38S  
part# NW38FL

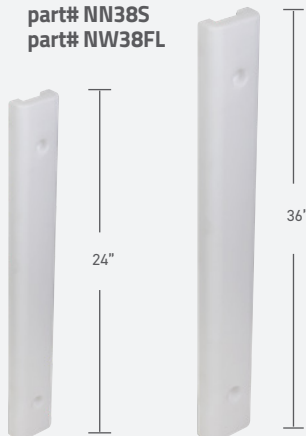

## PIER BUMPER

Mount on the sides of any wood or metal dock.  
Marine-grade PVC.



Colors: White, Black, Blue, Tan, Light Gray, Khaki

White part# D1BPBWE  
Black part# D1BPBBK  
Blue part# D1BPBBE  
Tan part# D1BPBTN  
Light Gray part# D1BPBGYL  
Khaki part# D1BPBKI

Volume Pack 12 pcs  
(4 fasteners recommended per bumper, see page 3.)

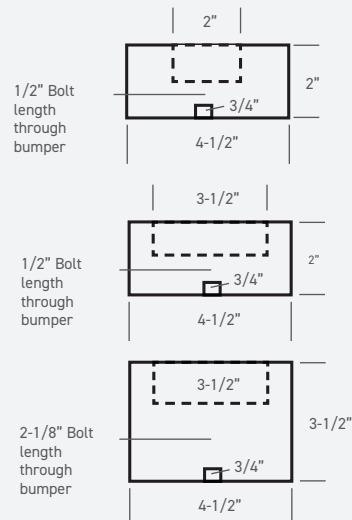
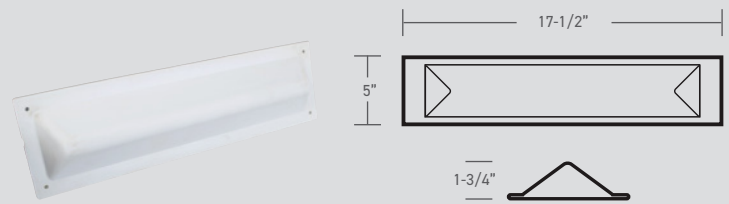

*Our bumpers mount easily on wood or metal docks for long-lasting enjoyment and protection.*

**CUSHION BUMPER**

Upper and lower lip wrap around the dock. Waffle effect backside for additional cushioning. Marine-grade PVC.

Colors:  
White, Black, Blue, Light Gray

White **part# D1BCBWE**  
Black **part# D1BCBBK**  
Blue **part# D1BCBBE**  
Light Gray **part# D1BCBGL**

Volume Pack 12 pcs  
(8 fasteners recommended per bumper, see page 3.)

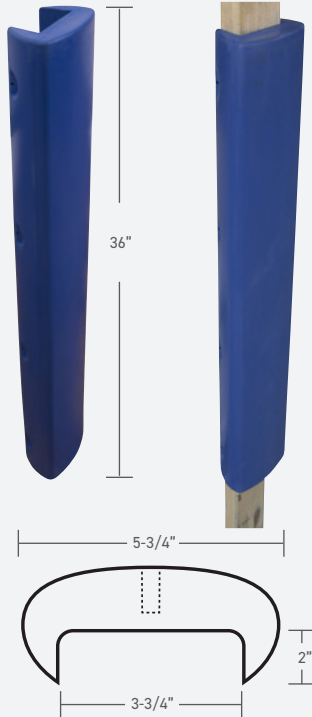

**PILING BUMPER**

Designed to mount vertically on pilings to provide protection to watercraft. The concave shape provides a perfect mating surface to pilings. Marine-grade PVC.

Colors:  
White, Black, Blue, Light Gray, Khaki

White **part# D1BPWE**  
Black **part# D1BPBK**  
Blue **part# D1BPBE**  
Light Gray **part# D1BPGYL**  
Khaki **part# D1BPKI**

Volume Pack 20 pcs  
(12 fasteners recommended per bumper, see page 3.)

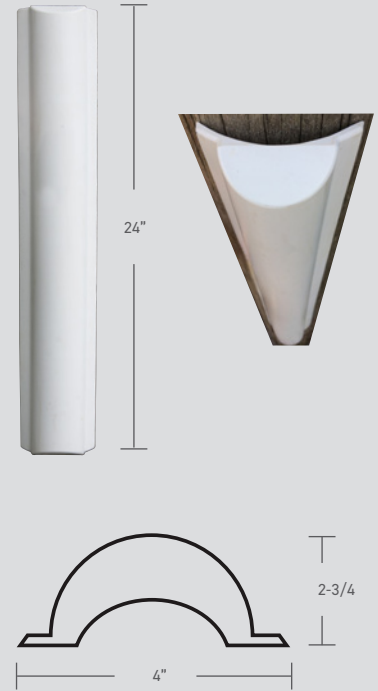

**43" FRAME BUMPER**

Durable polyethylene with UV inhibitors. Molded-in recessed mounting holes make the frame bumper easy to mount.

White **part# D1BUFRW**  
Black **part# D1BUFRB**  
Volume Pack 12 pcs

(Requires 4 bolts, 4 nuts and 8 washers per bumper)  
3/8" x 5" SS Hex Bolt **part# NB385G**  
used with wall thickness up to 1"  
3/8" x 6" SS Hex Bolt **part# NB386G**  
used with wall thickness up to 2"  
3/8" Brass Nut **part# NN38S**  
3/8" SS Flat Washer **part# NW38FL**

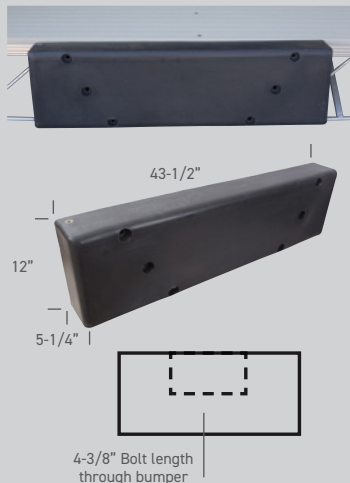

**48" POLY HARBOR CUSHION**

Durable polyethylene with UV inhibitors. Molded-in recessed mounting holes make the frame bumper easy to mount.

White **part# D1BPHSW**  
Black **part# D1BPHSB**

(Requires 4 bolts, 4 nuts and 8 washers per bumper)  
3/8" x 3" SS Hex Bolt **part# NB383G**  
used with wall thickness up to 1"  
3/8" x 4" SS Hex Bolt **part# NB384G**  
used with wall thickness up to 2"  
3/8" Brass Nut **part# NN38S**  
3/8" SS Flat Washer **part# NW38FL**

Volume Pack 12 pcs

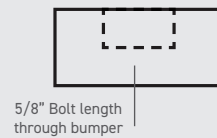

Matching corner on page 3.

**FRAME BUMPER BACKING PLATE**

3/8" x 2" Aluminum.

**part # D1BUFRP**  
Volume Pack 100 pcs



**POLY BUMPER BACKING PLATE**

3/8" x 2" Aluminum.

**part # D1BPHCP**  
Volume Pack 100 pcs



# RUB RAILS

With an extra-rugged design to withstand heavy impact, these rub rails are built to last. They will not crack, rot or deteriorate when exposed to temperature extremes. A UV inhibitor prevents yellowing and discoloring from sunlight. The rub rails are also unaffected by oil, gas or saltwater.



## 2" X 2" LIGHT DUTY ANGLE BUMPER

12' White  
part# LBUAN12

Volume Pack 12 pcs  
(48 fasteners recommended per bumper, see page 3.)

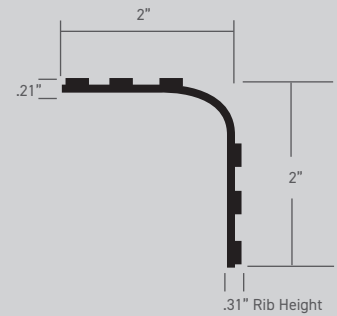
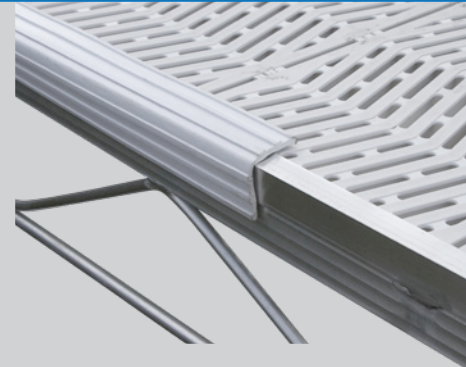

## 5002 RUB RAIL 10' LENGTH

White  
part# D1BUB5002W

Black  
part# D1BUB5002B

Dark Gray  
part# D1BUB5002GYD

Volume Pack 48 pcs  
(40 fasteners recommended per bumper, see page 3.)

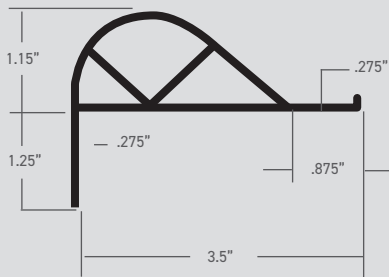
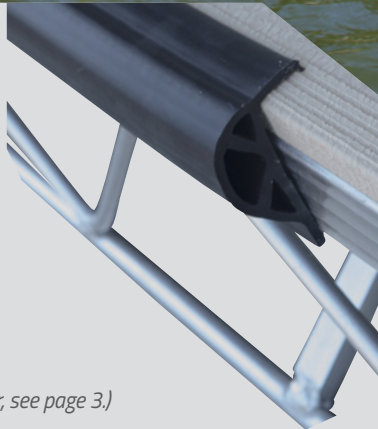

## 5001 RUB RAIL 10' LENGTH

White  
part# D1BUB5001W

Black  
part# D1BUB5001B

Volume Pack 50 pcs  
(40 fasteners recommended per bumper, see page 3.)

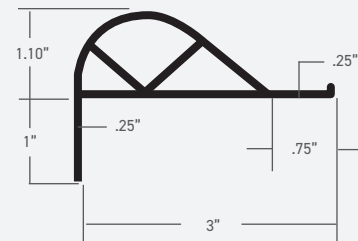
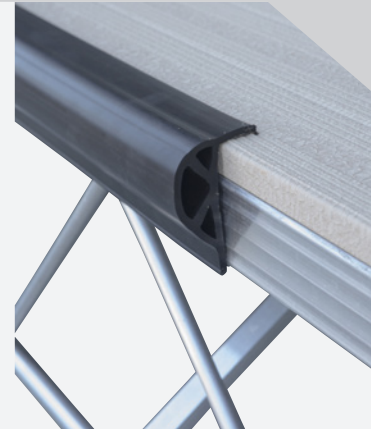



It is recommended that the rub rail of your boat comes in contact with the bumper rather than the bumper to come in contact with the sides of your boat as this can result in serious damage to the sides of your boat.

BUMPER COLORS

White

Black

Light Gray

*Protect your boat and dock area. Rugged construction withstands oil, gas and saltwater. UV inhibitor prevents discoloring.*

**5007 RUB RAIL  
10' LENGTH**

White  
part# D1BUB5007W

Black  
part# D1BUB5007B

Volume Pack 48 pcs  
(40 fasteners recommended  
per bumper, see page 3.)

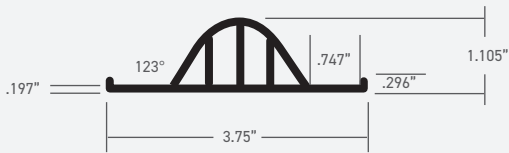

**Quality and workmanship  
since 1971.**



# ROUND POST CAPS & COVERS

BUMPER COLORS

White

Black

Blue

Green

*Finish off your dock with style. Caps provide a safe and streamlined top to poles.*

## POLE COVER

The 36" pipe covers are designed to slide over 1-1/4", 1-1/2" or 2" dock pipe to provide a uniform look to your dock. They can be trimmed to any size for custom applications.

Material: Marine-grade PVC

Installation: Trim the pipe covers to your desired length and slide them over your dock pipe.

Slides easily over dock pipes.

Colors: White, Black, Blue, Green, Tan, Light Gray, Khaki

Volume Pack 12 pcs

### Small Cover - 2" ID for 1-1/4" and 1-1/2" Pipe

White	part# D1PG114WE
Black	part# D1PG114BK
Blue	part# D1PG114BE
Green	part# D1PG114GN
Tan	part# D1PG114TN
Light Gray	part# D1PG114GYL
Khaki	part# D1PG114KI

### Large Cover - 2-3/4" ID for 2" Pipe

White	part# D1PG2WE
Black	part# D1PG2BK
Blue	part# D1PG2BE
Green	part# D1PG2GN
Tan	part# D1PG2TN
Light Gray	part# D1PG2GYL
Khaki	part# D1PG2KI



## ROUND RUBBER PIPE CAP

Round marine-grade vinyl caps fit over the top of dock pipes.

Colors: Blue, Red, Black, White, Green, Tan, Light Gray, Teal, Khaki

Volume Pack 100 pcs



### WITH ROUND TOP

#### 1-1/4" Cap for 1-1/2" OD Pipe

White	part# D1RRC1-1/4WE
Green	part# D1RRC1-1/4GN
Light Gray	part# D1RRC1-1/4GYL
Khaki	part# D1RRC1-1/4KI

#### 1-1/2" Cap for 1-3/4" OD Pipe

Blue	part# D1RRC1-1/2BE
Red	part# D1RRC1-1/2RD
Black	part# D1RRC1-1/2BK
White	part# D1RRC1-1/2WE
Green	part# D1RRC1-1/2GN
Light Gray	part# D1RRC1-1/2GYL
Teal	part# D1RRC1-1/2TL
Khaki	part# D1RRC1-1/2KI

#### 2" Cap for 2-1/4" OD Pipe

Black	part# D1RRC2-BK
White	part# D1RRC2-WE
Green	part# D1RRC2-GN
Tan	part# D1RRC2-TN
Light Gray	part# D1RRC2-GYL
Teal	part# D1RRC2-TL

### WITH FLAT TOP

#### 1-1/4" Cap for 1-1/2" OD Pipe

Blue	part# D1RC114BE
Red	part# D1RC114RD
Black	part# D1RC114BK
White	part# D1RC114WE
Green	part# D1RC114GN
Tan	part# D1RC114TN
Light Gray	part# D1RC114GYL

#### 1-1/2" Cap for 1-3/4" OD Pipe

Blue	part# D1RC112BE
Red	part# D1RC112RD
Black	part# D1RC112BK
White	part# D1RC112WE
Green	part# D1RC112GN
Tan	part# D1RC112TN
Light Gray	part# D1RC112GYL

#### 2" Cap for 2-1/4" OD Pipe

Blue	part# D1RC2BE
Red	part# D1RC2RD
Black	part# D1RC2BK
White	part# D1RC2WE
Green	part# D1RC2GN
Tan	part# D1RC2TN
Light Gray	part# D1RC2GYL

#### 2-11/16" Dock Post, 2-15/16" ID

White	part# D1RC211/16
-------	------------------





Tan

Light Gray

Dark Gray

Chocolate

Red

Khaki

Teal

# SQUARE END CAPS & PLUGS

## SQUARE RUBBER CAP

	ID	Part Number
1-1/2" square	1-1/2"	<b>D1RC1SQ</b>
2" square	2"	<b>D1RC2SQ</b>
3" square	3"	<b>D1RC3SQ</b>
2" x 4"	2" x 4"	<b>LRARC</b>

Volume Pack 50 pcs



## SQUARE PLASTIC HOLE PLUG

	ID	Part Number
1-1/2" square	1-1/4"	<b>D1PC1SQ</b>
2" square	1-3/4"	<b>D1PC2SQ</b>
3" square	2-3/4"	<b>D1PC3SQ</b>

Volume Pack 50 pcs



## RUBBER POST PLUG

	ID	Part Number
2" square	1-3/4"	<b>LCGBPLUG</b>





# DOCK CLEATS

## DOCK CLEAT SEAT

Heavy-duty, folding tie-down.  
Bolts to any flat surface with six mounting holes.  
Pivots on stainless steel pin, not just a plastic dimple.

Tensile Strength: 27,000 PSI Rated for: 1/2" Rope Mounting  
Hardware: 1/4" Lag Screw 1/4" Hex Head (not included).

Volume Pack 25 pcs

Black  
White  
Cleat Hardware

part# D1CSB  
part# D1CSW  
part# D1CSH

See bottom of this page.

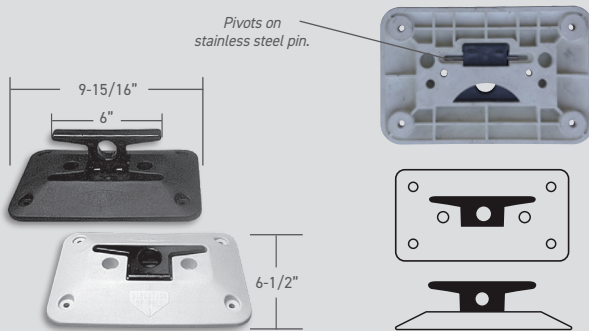

## DOCK CLEAT SEAT HARDWARE

Securely mount your cleats to your dock. For aluminum, cedar and ThruFlow decking up to 2" thick. (Mounts 4 cleats)

part# D1CSH  
Volume Pack 10pcs



## DECKING BACKER

Reinforcement backer plate used under the deck of dock to help secure dock ladders and cleats.  
Fits up to 1-1/4" tube.

Backer  
part# D1DDB

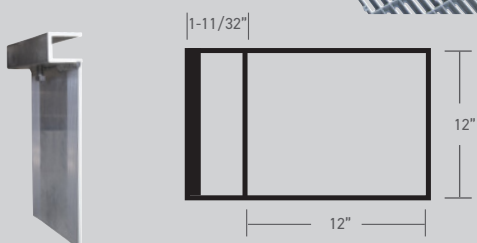

## NYLON DOCK CLEAT

Cleats are injection molded in black nylon for long-lasting strength and durability.



6" (Volume Pack 25)

(Requires two bolts, nuts and washers per cleat)  
1/4" x 2-1/2" SS Carriage Bolt  
used with deck thickness up to 1-1/4"  
1/4" x 3-1/2" SS Carriage Bolt  
used with deck thickness up to 2-1/4"  
1/4" Coated Nut  
1/4" SS Flat Washer

part# D1CN6  
part# NB14212C  
part# NB14312C  
part# NN14S  
part# NW14FL

8" (Volume Pack 25)

(Requires two bolts, nuts and washers per cleat.)  
5/16" x 2-1/2" SS Carriage Bolt  
Used with deck thickness up to 1/2".  
5/16" x 3-1/2" SS Carriage Bolt  
Used with deck thickness up to 1-1/2".  
5/16" Brass Nut  
5/16" SS Flat Washer

part# D1CN8  
part# NB516212C  
part# NB516312C  
part# NN516B  
part# NW516FL

10" (Volume Pack 25)

(Requires two bolts, nuts and washers per cleat.)  
5/16" x 2-1/2" SS Carriage Bolt  
Used with deck thickness up to 1/2".  
5/16" x 3-1/2" SS Carriage Bolt  
Used with deck thickness up to 1-1/2".  
5/16" Brass Nut  
5/16" SS Flat Washer

part# D1CN10  
part# NB516212C  
part# NB516312C  
part# NN516B  
part# NW516FL

## S-CLEAT

Secure your boat quickly and easily with the 10" cast-aluminum "S" dock cleat. Made of corrosion-resistant aluminum for enhanced durability. Oversized horns make it easy to loop large ropes. "S" cleat has recessed mounting holes to reduce the chance of line snag and fray.

10" (Volume Pack 20) part# D1CS10  
12" (Volume Pack 20) part# D1CS12  
15" (Volume Pack 10) part# D1CS15

(Requires two bolts, nuts and 4 washers per cleat.)  
7/16" x 3" part# NB7163G Used with deck thickness up to 1/2"  
7/16" x 4" part# NB7164G Used with deck thickness up to 1-1/2"  
7/16 Nut part# NN716S  
1/2" SS flat washer part# NW12FL

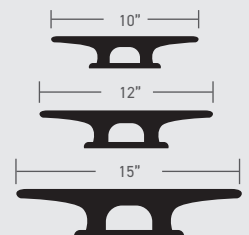
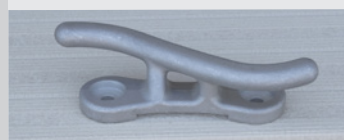

*Securely moor your watercraft at marine facilities and private docks.*

**6" ALUMINUM CLEAT**

Heavy-duty commercial cleat for use on inland waters with boats up to 18'.  
Cast, White or Black.

Volume Pack 50 pcs

Cast **part# D1CA6C**  
White **part# D1CA6W**  
Black **part# D1CA6B**

(Requires two bolts, nuts and washers per cleat.)  
3/8" x 1-1/2" SS Hex Bolt **part# NB38112G**  
Used with deck thickness up to 3/4".  
3/8" x 2" FT SS Hex Bolt **part# NB382FT**  
Used with deck thickness up to 1-1/4".  
3/8" Brass Nut **part# NN38S**  
3/8" SS Flat Washer **part# NW38FL**

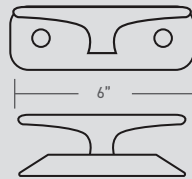

**MINI CLEAT**

3" mini cleat's compact design is excellent for tying up canoes, chairs to the docks and for mooring small fishing boats.

Volume Pack 100 pcs

White **part# D1CMW**  
Black **part# D1CMB**  
Cast **part# D1CMC**

Cleat Hardware **part# D1CSH**  
Kit includes hardware for mounting eight mini cleats. Used with deck thickness up to 2".

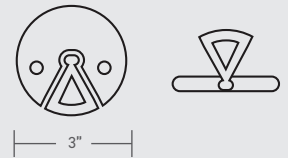

**GALVANIZED CLEATS**

Heavy-duty galvanized cleat in three sizes (Bolts not included).

**8"** (Volume Pack 50) **part# D1CG8**  
(Requires two bolts, nuts and washers per cleat.)  
5/16" x 2-1/2" SS Hex Bolt **part# NB516212G**  
Used with deck thickness up to 3/4".  
5/16" x 3-1/2" SS Hex Bolt **part# NB516312G**  
Used with deck thickness up to 1-3/4".  
5/16" Brass Nut **part# NN516B**  
5/16" SS Flat Washer **part# NW516FL**

**10"** (Volume Pack 30) **part# D1CG10**  
(Requires two bolts, nuts and washers per cleat.)  
3/8" x 3" SS Hex Bolt **part# NB383G**  
Used with deck thickness up to 3/4".  
3/8" x 4" SS Hex Bolt **part# NB384G**  
Used with deck thickness up to 1-3/4".  
3/8" Brass Nut **part# NN38S**  
3/8" SS Flat Washer **part# NW38FL**

**12"** (Volume Pack 20) **part# D1CG12**  
(Requires two bolts, nuts, washers per cleat.)  
7/16" x 3" SS Hex Bolt **part# NB7163G**  
Used with deck thickness up to 1/2".  
7/16" x 4" SS Hex Bolt **part# NB7164G**  
Used with deck thickness up to 1-1/2".  
7/16" Brass Nut **part# NN716S**  
1/2" SS Flat Washer **part# NW12FL**

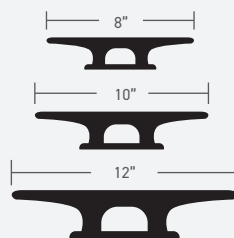

**8" ALUMINUM CLEAT**

For larger boats on larger bodies of water.

Cast, White or Black powder-coated.

White (Volume Pack 25) **part# D1CA8W**  
Black (Volume Pack 25) **part# D1CA8B**  
Cast (Volume Pack 30) **part# D1CA8C**

(Requires two bolts, nuts and washers per cleat.)  
3/8" x 1-1/2" SS Hex Bolt **part# NB38112G**  
Used with deck thickness up to 3/4".  
3/8" x 2" FT SS Hex Bolt **part# NB382FT**  
Used with deck thickness up to 1-1/4".  
3/8" Brass Nut **part# NN38S**  
3/8" SS Flat Washer **part# NW38FL**

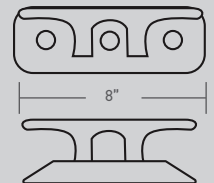
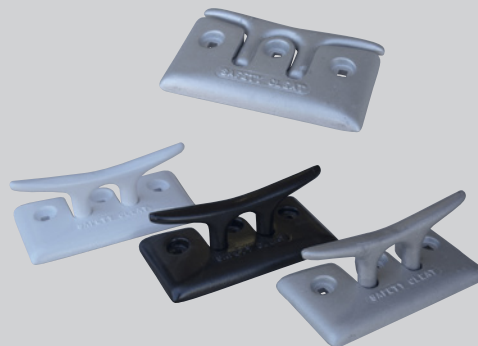



# LIGHTS

## POST LIGHT

Significantly brighter and of much higher quality than conventional solar garden lights. Lasts 18+ hours on a full charge. Automatically turns on the LED.

Pack includes Two Lights

part# D1LPOST

Volume Pack 12 pcs

Fits 1-5/8" OD Pipe  
Fits 1-7/8" OD Pipe  
Fits 2" OD Pipe  
Fits 2-3/8" OD Pipe  
Fits 3-1/4" OD Pipe



## DECK LIGHT

Resistant to salt water and harsh sun exposure. IP 68 waterproof design. Each unit includes an advanced user-replaceable solar rechargeable AAA battery which provides the maximum capacity power. Low profile, industrial strength aluminum with built in reflector. (104mm x 106mm)

One Light

Light part# D1LDECK

Volume Pack 24 pcs

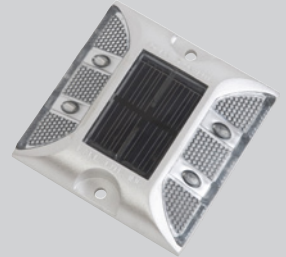



# ANCHORS & TIE-DOWNS

*Durable, heavy-duty accessories.*

## RAFT ANCHOR

Made of 100% high-density polyethylene. Fill it with sand and this 140 lb anchor will keep your raft in place.

Anchor **part# DF300003**

Volume Pack 6 pcs



## HIGH-WIND TIE-DOWN

Keep your boatlift in place in rough or high-wind areas. Tie-down attaches to any rectangle or square tube up to 3"x3". Includes hardware, adjustable bracket, screw auger and two 5' aluminum posts.

High-Wind Tie Down Kit (2) **part# LLTD**

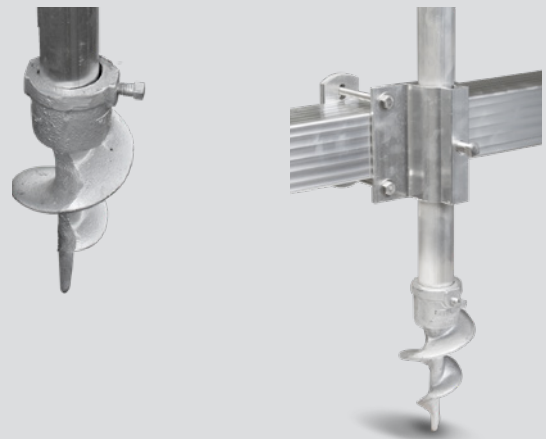

## DOUBLE CLEVIS KIT

Kit is designed for quick, easy attachment of an anchor to your swim raft using rope or chain.

The kit includes two 32" lengths of galvanized chain with a clevis at each end for attachment to the raft's eyelets. Two sections of stretch rope are provided as a flexible link that hooks between the eyelet at the center of the clevis chain and your anchor rope or chain.

Kit **part# DF300474**

Volume Pack 6 pcs



## TIE-DOWN

Personal watercraft and small boat mooring made easy. Simply screw in. Removable handle stows inside anchor tube.

Tie-Down **part# L1TD**

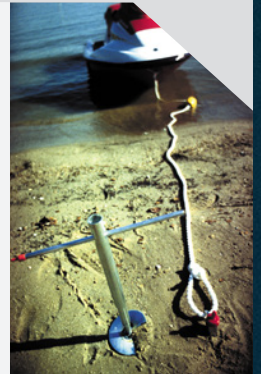

## TIE-DOWN KIT

Includes 15' anchor line, float and nylon carry bag. The original "Beach Security Anchor" from Tie Down. Ideal for mooring personal watercraft or small boats. Screws in easily. Removable handle stows inside anchor tube.

Tie-Down Kit **part# L1TDK**



# STORAGE BOXES & COOLERS

## WAVE ARMOR COOLERS

Thick and rugged roto-molded polyethylene. Grizzly Bear Certified by National Park Service. Other features include pressure-injected polyurethane insulation, saltwater-tested hinge pins and hardware and freezer-quality gasket. Aluminum core foam encased handles and quick-release compression lid latches make handling easy. Oversized non-slip, non-marking feet, quick-turn drain plug with gasket, hold-fast tie down slots and secure padlock thru-holes (lockable).

- 22-quart Cooler  
part# DF301548-WHITE
- 22-quart Cooler  
part# DF301549-BLUE
- 32-quart Cooler  
part# DF301550-WHITE
- 32-quart Cooler  
part# DF301551-BLUE
- 42-quart Cooler  
part# DF301034-WHITE
- 42-quart Cooler  
part# DF301316-BLUE



## UNIVERSAL STORAGE BOX

High-impact molded polyethylene and UV protection. Pebble Beach Textured Finish.

Storage Box **part# DF301093**

Attaches to 5' Universal Bench, see page 27.

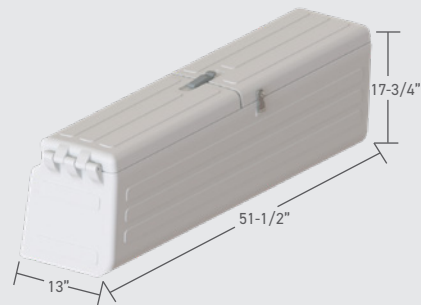

## POLYETHYLENE STORAGE BOX

Molded handles and double-walled lid. Water and dust resistant. Lockable.

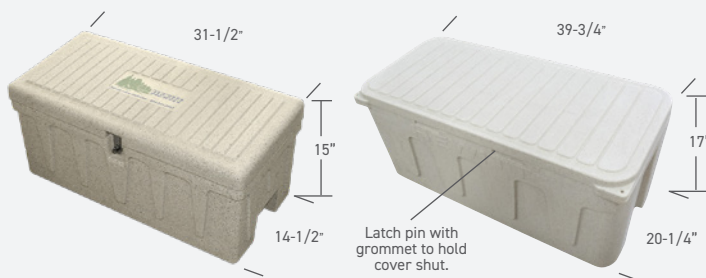

Standard Box  
part# L1HYPB

Medium Box  
part# L1HYPBL

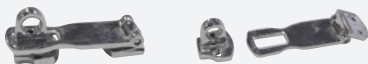

Lock



Latch

## FISHING ROD/CUP HOLDER

Rigid aluminum bracket mounts to 1-1/2" outside diameter post. Two flush-mount cup holders and two mounted rod holders along with a spot for a needle-nose pliers.

Holder  
part# D1ROD



# ROLL-IN WHEELS

*Heavy-duty plastic dock wheels feature UV and antifungal protection.*

## 18" AND 24" ROLL-IN WHEEL

For use with roll-in dock and lift applications. Wheels weigh 12 pounds each with an estimated weight limit of 750 pounds each or 1500 pounds per pair. High strength plastic wheel with UV protection.

Colors: Black

18" Diameter, 8" Wide  
Volume Pack 40 pcs

1-1/4" axle, 1-5/8" od  
**part# D1TIRE18-114**

1-1/2" axle, 1-7/8" od  
**part# D1TIRE18-112**

2" axle, 2-3/8" od  
**part# D1TIRE18-2**



24" Diameter, 8" Wide  
Volume Pack 40 pcs

1-1/4" axle, 1-5/8" od  
**part# D1TIRE114**

1-1/2" axle, 1-7/8" od  
**part# D1TIRE112**

2" axle, 2-3/8" od  
**part# D1TIRE2**



## HEWITT 16" AND 27" PLASTIC TIRE

Standard tires in three sizes. Polyethylene tire features seamless construction and venting.

27" Tire (18lbs )  
1" axle  
**part# DWHEEL**

27" Heavy-Duty Tire ( 24lbs )  
1" axle  
**part# DWHEELHD**

16" Tire (12lbs )  
1" axle  
**part# DWHEELS**



## 25" OTTER TIRE

Polyethylene tire with seamless construction and venting.

1-7/8" Axle Opening.

Vented (14lbs)  
**part# DF300449**

Non-Vented (14lbs)  
**part# DF300450**

Volume Pack 25 pcs



**Heavy-duty accessories  
and parts that are  
built to last.**



# LADDERS

## HEAVY-DUTY ALUMINUM LADDER

Heavy-duty 1-1/2" square corrosion-resistant aluminum.

Ladder features 3-1/2" extruded aluminum channel serrated to produce a non-skid surface rung with no sharp edges. Ladder rated 665 lb per rung.

4 steps **part# D1LADA4**

4 steps (2-piece)  
(For shipping UPS) **part# D1LADA42**

6 steps **part# D1LADA6**

6 steps (2-piece)  
(For shipping UPS) **part# D1LADA62**

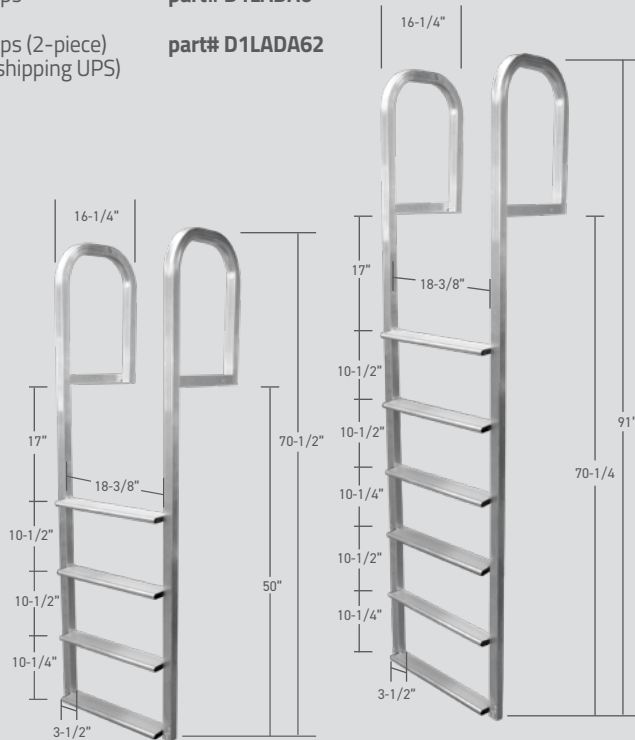

## WAVE ARMOR LADDER

100% polyethylene. Integrates with the Wave Armor system.

Folds up and out of the water when not using.

Bottom section of ladder floats.

Ladder  
**part# DF300081**

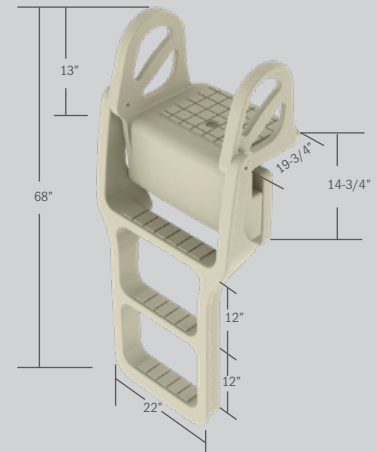

## LADDER MOUNTING HARDWARE

Hardware for mounting 4 and 6-step ladders. Use with deck thickness up to 2".

Hardware  
**part# D1LADM**



## DECKING BACKER

Reinforcement backer plate used under the deck of dock to help secure dock ladders and cleats. Fits up to 1-1/4" tube.

Backer  
**part# D1DDB**

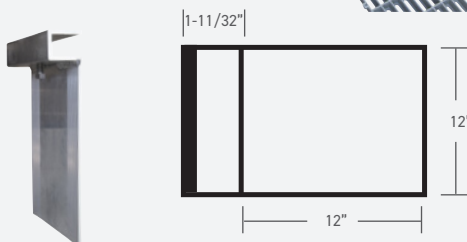

## ALUMINUM LADDER HINGES

Aluminum hinge lets you swing the ladder into an upright position. One pair.

Hinges  
**part# D1LADH**

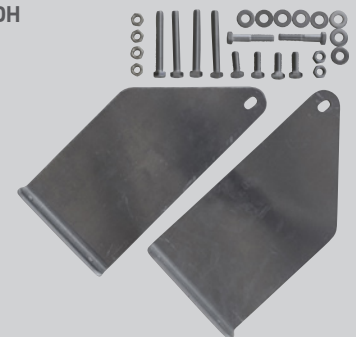

*Ladders and stairs constructed with long-lasting durability and good looks.*

### 3, 4 OR 5-STEP METAL LADDERS

Galvanized or Powder-coated blue.  
Optional speed release. 5" step.

3-step Galvanized  
**part# DH28273**

3-step Powder-coated  
**part# DH27273**

4-step Galvanized  
**part# DH28274**

4-step Powder-coated  
**part# DH27274**

5-step Galvanized  
**part# DH28275**

5-step Powder-coated  
**part# DH27275**

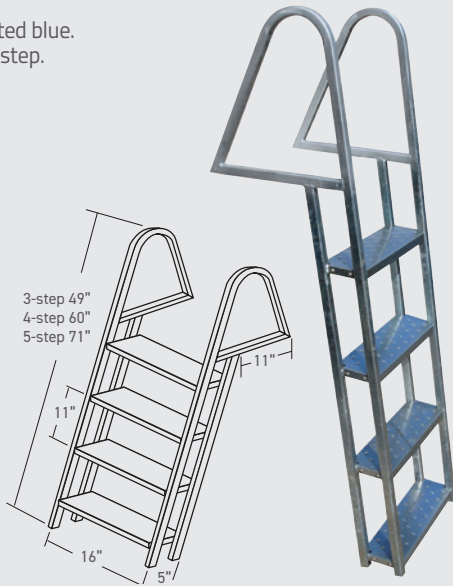

### OPTIONAL GALVANIZED SPEED-RELEASE

Used with galvanized and blue powder-coated ladders only.

Speed-release **part# DH27271**



### STRAIGHT LADDER

Brackets mount on side or end of Ultra Dock and Classic Dock. Four-step straight ladder has three mounting holes and bolts to bracket at a 10-degree angle.

Classic  
**part# D1LADAC**

Ultra  
**part# D1LADAU**



Classic Bracket Only  
**part# D1LADC1**



Ultra Bracket Only  
**part# D1LADU1**



Judge, Northern Lights,  
and Floe require the  
Ultra Bracket.





# STEPS & STAIRS

## ALUMINUM DOCK 4-STEP

Aluminum steps with 2" x 5-1/2" powder coated tread. The step system comes with attachment bracket that fits most docks, two hand railings and two 16" front legs with pads.

- Dock 4 Step - White
- Dock 4 Step - Beige
- Dock 4 Step 25" Legs (1)

part# D1STEP4  
part# D1STEP4B  
part# D1STEP5L25

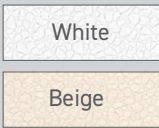
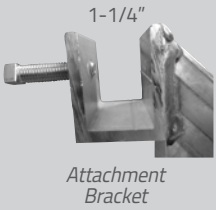

## ALUMINUM DOCK 5-STEP

Heavy-duty aluminum construction. 5-step with 3-1/2" tread step and two hand railings. Includes attachment bracket and two 16" legs.

- Dock 5-Step - Aluminum
- Dock 5-Step - 25" Legs(1)

part# D1STEP5  
part# D1STEP5L25

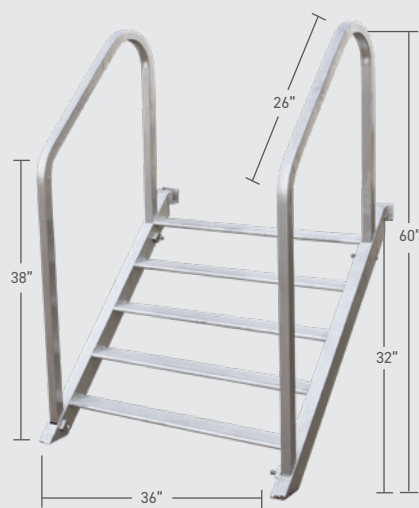
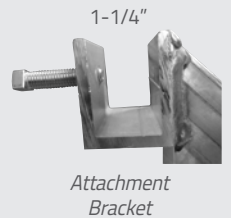



*Need something custom?  
Talk to our helpful staff for the perfect fit.*

### DOCK 3-STEP WITH SOLID SIDES

Perfect for areas with a rise from the shore to the deck of the dock. Aluminum construction with 36" powder coated stair treads. Top step is 24" tall, longer lengths available.

- Dock 3 step stairs (beige)
- Dock 3 step with railing (beige)
- Dock 3 step stairs (white)
- Dock 3 step with railing (white)

part# D1STEP3B  
part# D1STEP3BWR  
part# D1STEP3W  
part# D1STEP3WWR

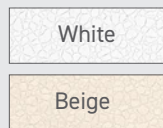

### ADJUSTABLE STEPS

36" stair treads and landings are made from QT powder coated aluminum. Baked-on finish provides sure footing when wet. Aluminum construction. Custom widths available. See dealer for ThruFlow™ decking.

- 3' Adjustable steps (3' to 4-1/2')
- 5' Adjustable steps (5' to 7-1/2')
- 3' Adjustable steps (beige 3' to 4-1/2')
- 5' Adjustable steps (beige 5' to 7-1/2')

part# D1STEPA3  
part# D1STEPA5  
part# D1STEPAB3  
part# D1STEPAB5



### CUSTOM ADJUSTABLE STEPS

Custom designs, lengths and widths. Step tread is 9.6" Optional non-adjusting steps have 2" x 8" solid side tube. Custom colors and painted handrailings also available. Railing and siderails shown at right include custom paint option.

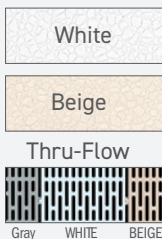

Aluminum  
Bullnose Step

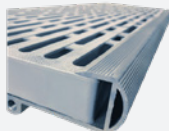

ThruFlow  
Bullnose Step

# SEATING & UMBRELLAS

## FREESTANDING BENCH

Mount easily to a flat surface. Includes aluminum brackets. Shown with powder coated aluminum planks. (Umbrella not included.)

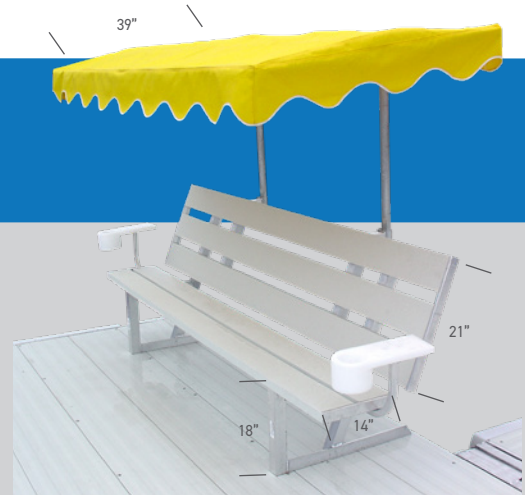

## BENCH SEAT OPTIONS

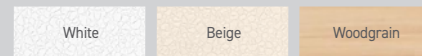

## BENCH UMBRELLA

All-aluminum construction umbrella mounts easily to the back of your bench. 32" adjustment.

Vinyl Umbrella  
4' part# D1U4 color  
8' part# D1U8 color

Defender Umbrella  
4' part# D1US4 color  
8' part# D1US8 color

Aluminum  
4'

(2" x 6") bench kit & bolts (white)

part# D1BFA4A

(2" x 6") bench kit & bolts (beige)

part# D1BFA4AB

(2" x 6") bench kit & bolts (woodgrain)

part# D1BFA4W

8'

(2" x 6") bench kit & bolts (white)

part# D1BFA8A

(2" x 6") bench kit & bolts (beige)

part# D1BFA8AB

(2" x 6") bench kit & bolts (woodgrain)

part# D1BFA8W

Bench bracket kit (w/bolts, no wood)

part# D1BFA

View larger color swatches on page 74.

## VINYL CANOPY COLORS



## DEFENDER FABRIC CANOPY COLORS



## OFFSET BENCH

When mounted to the dock, the bench is over the water, not on the deck, leaving more deck space. All-aluminum construction.

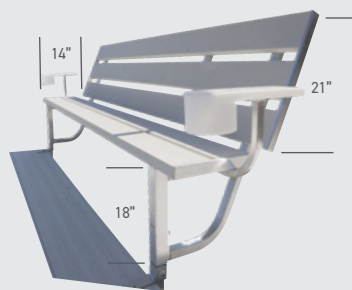

## BENCH ARMREST WITH CUP HOLDER

Large armrest has deep rotational cup holder and holds up to a 3-1/2" diameter cup.

Armrest with Cup holder part# D1BAR

## Offset Bench for 4' wide docks

Aluminum  
4'

(2" x 6") bench kit & bolts (white)

part# D1BA4A

(2" x 6") bench kit & bolts (beige)

part# D1BA4AB

8'

(2" x 6") bench kit & bolts (white)

part# D1BA8A

(2" x 6") bench kit & bolts (beige)

part# D1BA8AB

Bench bracket kit (w/bolts, no wood)

part# D1BA

## Offset Bench for 6' wide docks

Aluminum  
4'

(2" x 6") bench kit & bolts (white)

part# D6BA4A

bench kit & bolts (beige)

part# D6BA4AB

8'

bench kit & bolts (white)

part# D6BA8A

bench kit & bolts (beige)

part# D6BA8AB

Bench bracket kit (w/bolts, no wood)

part# D6BA





### 30" TABLE

Low-maintenance powder-coated aluminum mesh table. Includes hole for optional umbrella. Optional bracket for mounting table to dock.

- Table only
- Table with Dock Bracket
- Table with Classic Dock Bracket
- Table with Powder Coated Wave Dock Bracket
- Table with Universal Dock Bracket (Floe, Northern Lights, Judge, Ultra)

- part# DPTABLE
- part# DPTABLER
- part# DPTABLEC
- part# DPTABLEW
- part# DPTABLEU



Holes are 4" on center

4"

Dock Bracket  
part# DPBRKTR



Classic Bracket  
part# DPBRKTC



Universal Bracket  
part# DPBRKTU



Wave Dock Bracket  
part# DPBRKTW

### PATIO CHAIR

Powder-coated aluminum, adjustable swivel rocker mechanism. Chair is wrapped with two layers of fabric and is durable and comfortable. Optional bracket for mounting chair to dock.

- Chair only
- Chair with Dock Bracket
- Chair with Classic Dock Bracket
- Chair with Powder Coated Wave Dock Bracket
- Chair with Universal Dock Bracket (Floe, Northern Lights, Judge, Ultra)

- part# DPCHAIR
- part# DPCHAIRR
- part# DPCHAIRC
- part# DPCHAIRW
- part# DPCHAIRU

*Floe, Northern Lights and Judge are in no way associated with the products of Great Lakes Marine.*

### UNIVERSAL DOCK AND PATIO BENCH

For use in virtually any outdoor location, residential and commercial. Weatherproof and maintenance-free. Pebble Beach color.

Weatherproof and UV resistant. Molded-in beverage holders and high-impact polyethylene molded construction.

4' Bench: 52"W x 37"H x 27"D. 66 lbs.  
part# DF300014

5' Bench: 64"W x 37"H x 27"D. 81 lbs.  
part# DF301092

6' Bench: 76"W x 37"H x 27"D. 96 lbs.  
part# DF300016



Recessed Sides - Side support seat, not just a bolt.



### UNIVERSAL STORAGE BOX

High-impact molded polyethylene and UV protection. Pebble Beach Textured Finish. (Fits 5' Bench only)

Storage Box part# DF301093

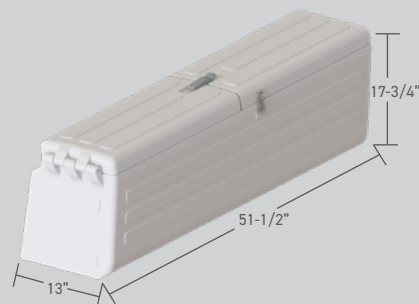

# DOCK BRACING & AUGERS

## ALUMINUM CROSS BRACE KIT

Add stability in muddy or deep water. Heavy-duty extruded ends slide over pipe and secure with set screws. (complete X)

Length	ID	Part #
5' kit	1-3/4"	<b>DS1095</b>
8' kit	1-3/4"	<b>DS108</b>
5' kit	2-1/2"	<b>DS1095L</b>
8' kit	2-1/2"	<b>DS108L</b>



## QUICK CHANGE CROSS BRACING

Add strength to your dock without going under water. Galvanized steel dock leg bracing can be installed from top of your dock.

Fits pipe up to 1-1/2" OD pipe.  
 5' Pipe to Frame **part# DV1035**  
 6' Pipe to Pipe **part# DV1036**

Fits pipe up to 2-1/4" OD pipe.  
 7' Pipe to Frame **part# DV1037**

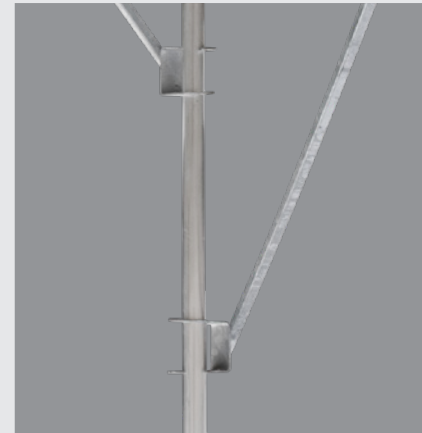

## SUPPORT STAND BRACKET

Galvanized	ID	Finish	Part#
2" medium	2"	galvanized	<b>DSBRACM</b>
2-1/2" large	2-1/2"	galvanized	<b>DSBRACLG</b>
3-1/4" extra large	3-1/4"	galvanized	<b>DSBRACXL</b>

Aluminum	ID	Finish	Part#
1-1/4" standard	1-3/4"	aluminum	<b>DABRAC</b>
2-1/2" large short	2-1/2"	aluminum	<b>DABRACLG</b>
2-1/2" large long	2-1/2"	aluminum	<b>DABRACGL</b>

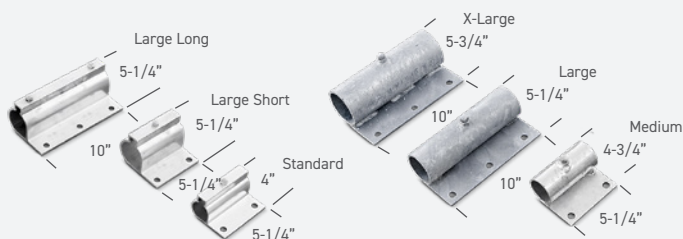

Brackets have 9/16" mounting holes on 4" centers.

## PIPE HOLDER/ 3" OUTSIDE "K"

Bolts to outside of dock. Use 2" pipe to hold dock in place.

Pipe Holder  
**part# DH26411**

Volume Pack 12 pcs

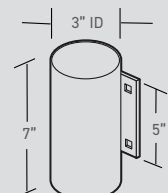

*Add stability and strength to your dock.  
Bracing and augers offer solutions for your unique location.*

## AUGERS

Auger attaches at end of post. Simply turn post to auger into the bottom of lake bed.

DB800-standard 1-5/8" inside diameter (slides over 1-1/4" pipe)  
**part# DAMUDP**

DB903-medium 1-7/8" inside diameter (slides over 1-1/2" pipe)  
**part# DAMUDPM**

DB400-large 2" outside diameter (slides inside 2" pipe)  
**part# DAMUDPLG**  
(Requires drilling and 3/8" x 3" bolt and nut.)

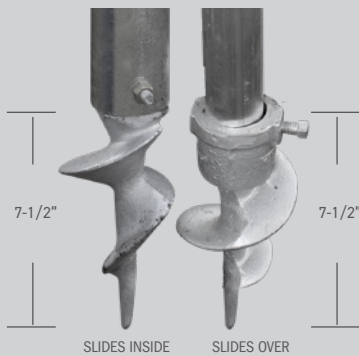

## POST RATCHET

Provides leverage to easily install and remove pipes with augers. This 19" handle and reversible ratchet fits 1-1/4", 1-1/2", and 2" pipes up to 2-1/4" O.D.

**part# DAPR**



Replacement Pin Assembly

**part# DAPRA**

*Installation requires drilling a 9/16" hole in post, a minimum of 2" down from the top.*

## SUPPORT STAND PIPES

Aluminum							
ID	OD	5'	8'	10'	12'	21'	24'
1-1/4"	1-1/2"	<b>DAP5</b>	<b>DAP8</b>	<b>DAP10</b>	<b>DAP12</b>	<b>DAP20</b>	N/A
Galvanized							
1-1/4"	1-1/2"	<b>DGP51/4</b>	<b>DGP81/4</b>	<b>DGP101/4</b>	<b>DAP121/4</b>	<b>DGP211/4</b>	<b>DGP241/4</b>
1-1/2"	1-3/4"	<b>DGP5M</b>	<b>DGP8M</b>	<b>DGP10M</b>	<b>DGP12M</b>	<b>DGP21M</b>	<b>DGP24M</b>
2"	2-1/4"	<b>DGP5L</b>	<b>DGP8L</b>	<b>DGP10L</b>	<b>DGP12L</b>	<b>DGP21L</b>	<b>DGP24L</b>
2-1/2"	2-3/4"	<b>DGP5XL</b>	<b>DGP8XL</b>	<b>DGP10XL</b>	<b>DGP12XL</b>	<b>DGP21XL</b>	<b>DGP24XL</b>
Galvanized pipe with auger and hole for post ratchet.							
2"	2-1/4"	<b>DGP8LWA</b>	<b>DGP10LWA</b>				





# WINCHES

## BRAKING WINCHES: REPLACEMENT OR UPGRADE

Winches feature a completely enclosed gear box with large cable spool. Crank one way to go up, the other way to go down. Stop in any position.

Volume Pack 6 pcs

B-1200	Gear Ratio 4:1	<b>part# LWB12</b>
B-1500	Gear Ratio 6:1	<b>part# LWB15</b>
B-2500	Gear Ratio 12:1	<b>part# LWB25</b>

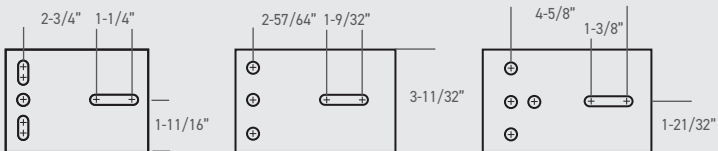
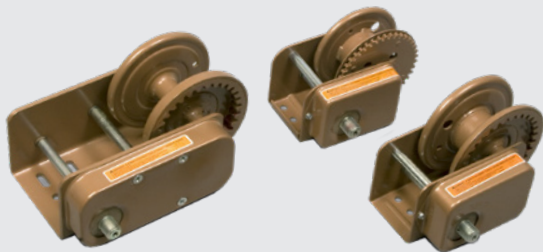

## HAND WINCH

Non-braking winch with a one-way ratchet system.

DL 1100 Winch	Gear Ratio 3.9:1 <b>part# DWINCH</b>
------------------	---

Crank handle Handle	<b>part# D304016</b>
------------------------	----------------------

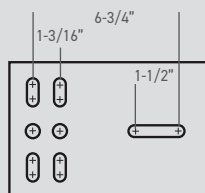

## POST WINCH KIT

Winch offers leverage for dock adjustment. Winch slides over dock post. Winch kit has a 2" inside diameter.

Kit **part# DAPW**

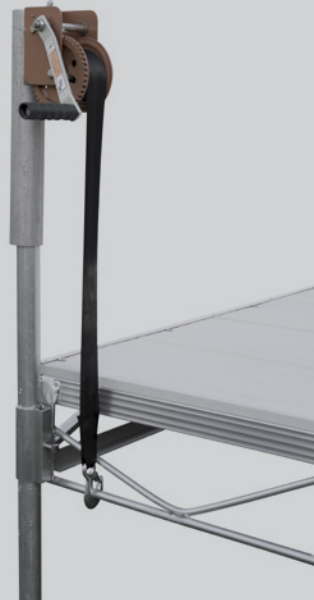

## LIFT JACK

Raise one end of the lift to easily adjust lift legs and assist with installing/removing lift wheels without going under water.

Lift jack handle is 36".

Lift Jack  
(with non-braking winch)  
**part# LWJ**

Lift Jack  
(with braking winch)  
**part# LWJB**



*Make dock adjustments fast and easy.*

### TRANSPORTATION BAR

Use a boat to move lift in and out of deep water or to a new location.

Bar    **part# LWTRAN**

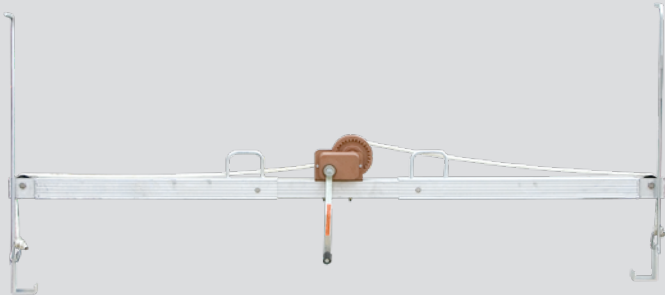

**Need something custom?  
Talk to our helpful staff.**



# KAYAKS & ACCESSORIES

## ALUMINUM KAYAK/CANOE RACK

1-1/2"x1-1/2" solid aluminum rack stores kayak/canoe. Includes paddle shelf and four loop tension cords.

Rack **part#D1KR**

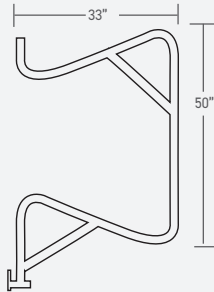

BRACKET FITS 1-1/4" TUBE



TENSION CORD

## PADDLEBOARD RACK

1-1/2" x 1-1/2" aluminum frame with 1" x 1" support arms. Arms have heavy-duty rubber sleeve for extra protection.

**part# D1PAT**



BRACKET FITS 1-1/4" TUBE

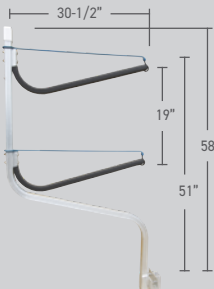

## UNIVERSAL KAYAK RACK

Universal Kayak Rack  
**part# DF300109**

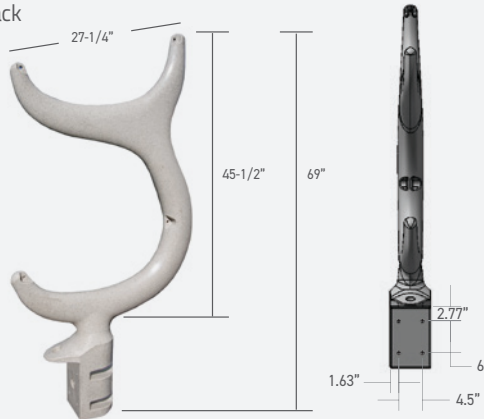

## PLASTIC KAYAK RACK

Molded-in kayak hook receivers secure kayak to rack. Attaches to Wave Armor Dock, special brackets available for mounting to truss or wood docks.

For Wave Dock  
**part# DF300107 (pair)**

Kayak Rack & Brackets for Truss and Wood Docks  
**part# DF300107K**

Bracket only for Truss and Wood Docks (1)  
**part# DF300107B**



1/2" Bolts are 4" on center.



BRACKET

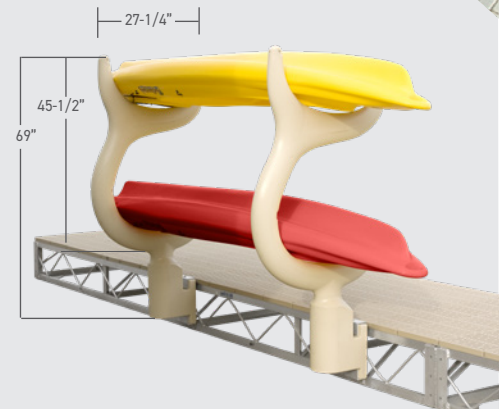

## KAYAK LAUNCH

Get in and out of kayaks and canoes with ease. Heavy-duty aluminum frame. Six adjustable settings. (Two loops)

Launch with Dock Bracket  
Launch with Classic Dock Bracket  
Launch with Wave Dock Bracket  
Optional Guide Bunk

**part#D1KLT**  
**part#D1KLC**  
**part#D1KLW**  
**part#NABBPB**

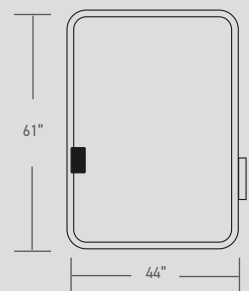
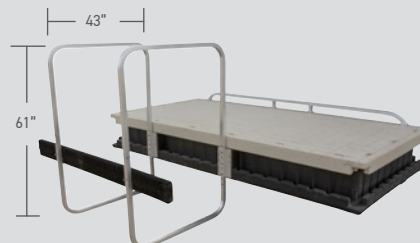



Care-free paddling. Durable kayaks and accessories make water fun easy.

### CRUIZER KAYAK

Our basic model made for the beginning paddler. Molded construction features beverage holders, footrests and handles. Spacious cockpit and high-speed hull. High-impact polyethylene provides maximum UV protection and superior stability. Available in blue or yellow.



Overall Dimensions:  
8'6" L x 30" W x 15" D  
Cockpit Dimensions:  
4' L x 23" W x 6" D  
185 lb Weight Capacity  
36 lb Kayak Weight

Kayak (blue)  
part# DF300440

Kayak (yellow)  
part# DF300441



### IMPULSE KAYAK

Sit-on-top style kayak is comfortable and ultra-stable. Designed for use on lakes or slower moving rivers by paddlers of all abilities. Weatherproof roto-molded polyethylene construction. Adjustable foam seat cushion, rear compartment and molded beverage holder, handles and grips provide added comfort. Available in blue or yellow.

Overall Dimensions:  
10' L x 32" W x 10" D

Cockpit Dimensions:  
4' L x 23" W x 6" D  
300 lb Weight Capacity  
45 lb Kayak Weight

Kayak (blue) part# DF300442  
Kayak (yellow) part# DF300443

Includes foam/neoprene seat cushion.

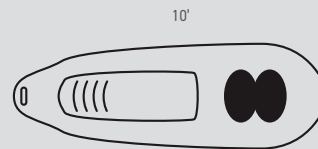

### KAYAK PADDLE

Two-piece, 7' paddle easily breaks down for storage and transport.

Paddle  
part# DF300089

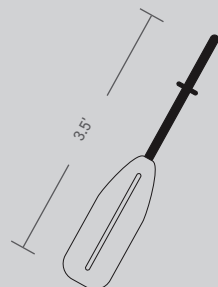

### KAYAK/CANOE STABILIZER KIT

Stabilizer Kit attaches to kayaks and canoes providing ultimate stability. Polyethylene Floats are nearly indestructible and can be adjusted up and down as well as in and out. Anodized aluminum and stainless steel parts will keep it lasting for years.

part# DF300117



# SLX WAVE PORT

*Designed to integrate with the Wave Dock System, stand alone or connect to other brands or structures.*



## SLX5 [5' X 12'8"]

part# DF301890

Weight: 286 lbs  
Weight Cap: 1500 lbs  
Allows two ports side-by-side fitting into a 10' slip.  
8 adjustable wheels.  
Volume Pack 6 pcs

## SLX6 [6' X 12'8"]

part# DF301891

Weight: 321 lbs  
Weight Cap: 2000 lbs  
Extra 6" on each side of the platform, creates a walking platform to and from the port and dock and allows standing room while mounting/dismounting your PWC. 10 adjustable wheels.  
Volume Pack 6 pcs

12.8' in length and constructed of thick, rugged, foam-filled polyethylene. These unsinkable ports utilize a proprietary foaming process which increases buoyancy and structural integrity. Molded mounting pockets in all four corners allow for numerous anchoring possibilities.

Both ports accommodate any size personal watercraft and include a removable bow stop with tie-down ring and adjustable, polyurethane-overlaid wheels which can be strategically placed in the port bed to evenly distribute weight and aid in the loading/unloading process. Pebble Beach textured finish designed to match the Wave Dock system.

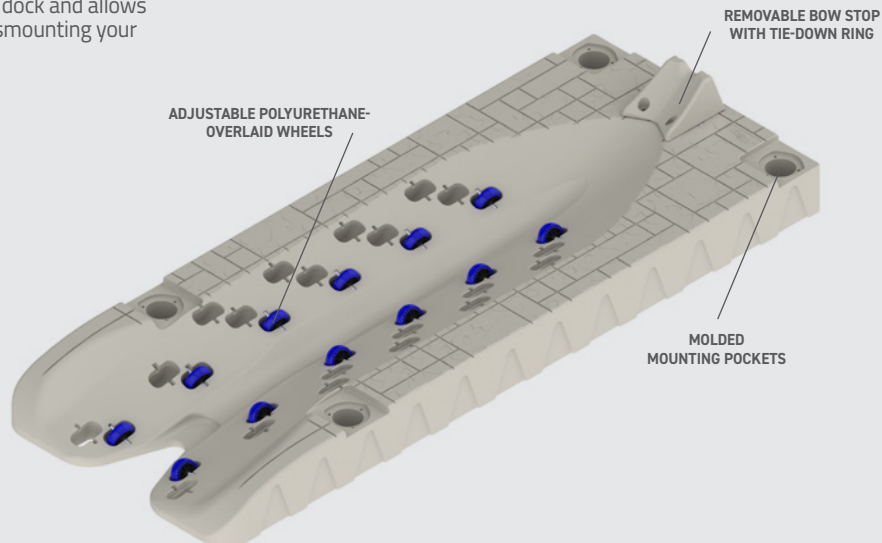



# SLX ACCESSORIES & ATTACHMENT KITS

## POST EXTENSION ATTACHMENT

Moves poles outside, increasing the distance between the two posts, allowing more room for larger PWCs.

2" Kit  
part# DF300095  
4" Kit  
part# DF300096



## Z-BRACKET ATTACHMENT KIT

Secures port to a fixed dock or sea wall.

2" Kit  
part# DF301281  
4" Kit  
part# DF301282



## PORT TO OTHER FLOATING DOCK BRANDS HINGE ATTACHMENT

Kits lock into dock C-channels.

19-3/4  
part# DF301308  
25-3/4  
part# DF301309



## PORT TO PORT ATTACHMENT

Connects a pair or multiple ports side-by-side.  
part# DF300046

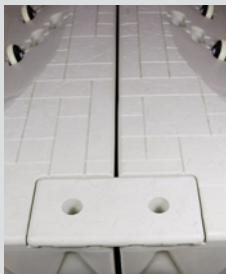

## BUOYANCY BOOSTER

Installs in the rear pockets, adds additional flotation to the rear of the port, decreasing the rearward pitch for heavier crafts.  
part# DF300498



## SNAP-IN CAP

Cover unused mounting pockets.  
part# DF300116



## BUSHING

Raised and flat reducer bushing. Raised design increases friction on post mount applications. 2"=2 1/2" ID. 4"=4 11/16" ID.

2" RAISED  
part# DF302202



4" FLAT  
part# DF301525



## TELESCOPING PORT TO FIXED DOCK KIT

2" kit adjusts from 16" to 24". (Two Ports)  
part# DF301434

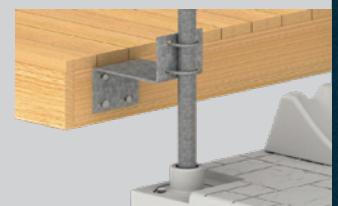

## SIDE EXTENSION

Adds 22" to one side.  
part# DF300115

Must purchase one port-to-port to attach side extension.

part# DF300046



## SLX PORT TO WAVE DOCK

part# DF301915



The best products  
all in one place.



# APEX SPORT & 6' APEX WAVE PORT

## APEX SPORT (5' X 11')

Apex Sport is specifically designed for smaller, lightweight PWCs (Sea-doo Sparks and Yamaha EX series) or stand up models. This Port features molded in direct connection pockets allowing it to be mounted as close as possible to the dock, creating the cleanest look.

The Apex Sport can stand alone, connect to the Wave Dock System or to other floating dock brands utilizing one of our Apex Sport Attachment Kits (Sold Separately).

### part# DF301901

Weight: 180 Lbs  
Weight Cap: 900 lbs  
12 adjustable wheels  
Volume Pack 6 pcs

- Rotationally Molded UV Protected Polyethylene
- Foam-Filled Interior
- Increases Buoyancy
- Molded-In Direct Connect Pockets
- 12 Adjustable Polyurethane Overlaid Wheels
- Tan Flagstone Textured Finish

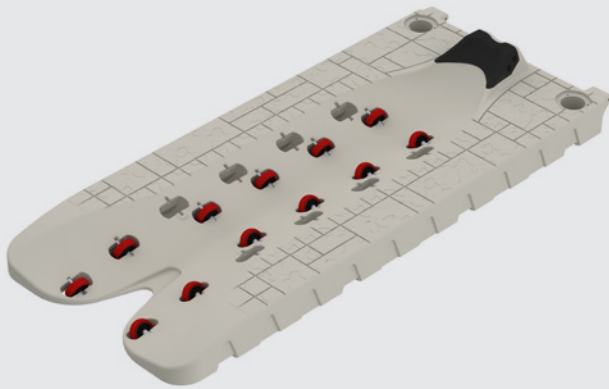

## 6' APEX WAVE PORT

Apex 6 is strategically designed with an extra 12" on the platform. It is the widest on the market, creating standing room while mounting/dismounting your PWC. It also creates a safe walking platform when walking to and from your dock.

Includes one set of snap-in caps.

### part# DF301903

Size: 72" x 14.4'  
Weight 340 lbs  
Weight Cap: 2000 lbs  
14 adjustable wheels  
Volume Pack 6 pcs

- Easiest and Largest Drive On / Roll Off PWC Port on The Market
- Foam-Filled Interior
- Adjustable Soft Urethane Wheels
- "Smart Stop" Soft Rubber Bow Stop
- Stainless Steel Chain
- Quick Clip Tie Down System

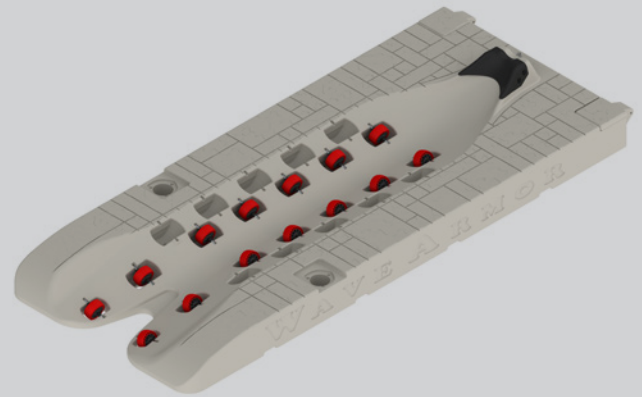

## APEX SPORT BOLT-IN CAPS

Finish the look with these bolt-in caps for a sleek finish. (2)  
part# DF301514



## APEX SPORT AND 6' APEX TO FLOATING DOCK KIT

These heavy-duty C-channel brackets allow for direct mount to a floating structure.  
part# DF301360



# APEX SPORT & 6' APEX ATTACHMENT KITS

## APEX SPORT AND 6' APEX POST EXTENSION ATTACHMENT

Moves poles outside, increasing the distance between the two posts, allowing more room for larger PWCs.

2" Kit  
part# DF300095  
4" Kit  
part# DF300096



## APEX SPORT AND 6' APEX Z-BRACKET ATTACHMENT KIT

Secures port to a fixed dock or sea wall.

2" Kit  
part# DF301281  
4" Kit  
part# DF301282



## TELESCOPING PORT TO FIXED DOCK KIT

2" kit adjusts from 16" to 24".  
part# DF301434

(Two Poles)

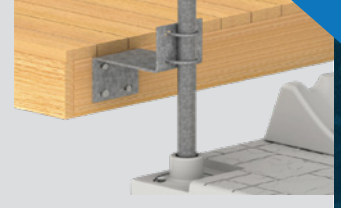

## APEX SPORT AND 6' APEX PORT TO PORT ATTACHMENT

Connects a pair or multiple ports side-by-side.  
part# DF300046

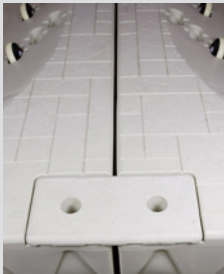

## APEX SPORT AND 6' APEX BUOYANCY BOOSTER

Installs in the rear pockets, adds additional flotation to the rear of the port, decreasing the rearward pitch for heavier crafts.  
part# DF300498



## 6' APEX SNAP-IN CAP

Cover unused mounting pockets.  
part# DF300116



## APEX SPORT AND 6' APEX BUSHING

Raised and flat reducer bushing. Raised design increases friction on post mount applications. 2"=2 1/2" ID. 4"=4 11/16" ID.

2" RAISED  
part# DF302202



4" FLAT  
part# DF301525



## 6' APEX PORT TO WAVE DOCK

part# DF301347

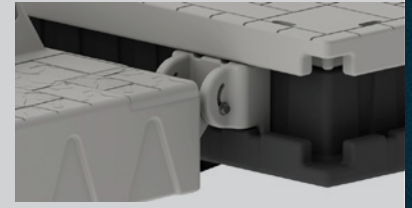

## APEX SPORT AND 6' APEX SIDE EXTENSION

Adds 22" to one side.  
part# DF300115

Must purchase one port-to-port to attach side extension.  
part# DF300046





# GENESIS & EXTREME WAVEPORT

## GENESIS BOAT PORT [16' AND 20' OPTION]

GENESIS is the largest of the Genesis Series Ports and a perfect alternative to conventional boat lifts. Its exclusive design allows you to expand the size of the port adjusting to a wide variety of boats and watercrafts. Its innovative design provides effortless drive on/roll off access, utilizing a self-centering adjustable wheel system and an innovative pin connection.

GENESIS 16  
part# DF301828

Size: 7' x 16'  
Weight: 500 Lbs  
Weight Cap: 2600 lbs  
16 adjustable wheels  
Volume Pack 6 pcs

GENESIS 20  
part# DF301832

Size: 7' x 20'  
Weight: 575 Lbs  
Weight Cap: 3200 lbs  
22 adjustable wheels  
Volume Pack 6 pcs

- Self-leveling Entrance
- 3.5" x 6" Wide Soft Wheels for Exceptional Support
- Optional 3.5" x 8" Wheels Available
- Rotationally Molded UV Protected Polyethylene
- Foam-Filled Interior Increases Buoyancy
- Tan Flagstone Textured Finish
- Molded-in Front Mounting Brackets Connect to Any Dock

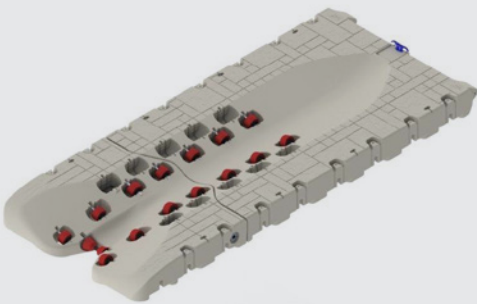

## EXTREME 16 TWO-PIECE WAVEPORT

Recommended for boats up to 18' in length. This self-leveling floating boat port fully distributes vessel weight over the full span, providing exceptional lift and buoyancy (up to 5,300 lbs with no air assistance). The modular design allows you to expand your boat port length infinitely for longer vessels. This large port features adjustable bunks to match any keel design (keeping the vessel square on the port) and heavy duty keel rollers that make boarding and off-boarding simple and smooth.

The EXTREME 16 Two-Piece Boat Port is 16 Feet long, 10 Feet wide and includes 1 Entrance Deck, 1 Main Deck, 4 Pin Connection Systems, 10 Bunk Rollers, 6 Heavy Duty Keel Rollers and 1 Keel Rest.

part# DF301979

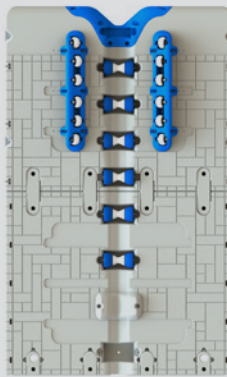

## EXTREME 24 THREE-PIECE WAVEPORT

Recommended for boats that are 18 to 30 feet in length. This self-leveling floating port fully distributes vessel weight over the full span, providing exceptional lift and buoyancy (up to 8,000 lbs with no air assistance). The modular design allows you to expand your boat port length infinitely for longer vessels. Features adjustable bunks to match any keel design (keeping the vessel square on the port) and heavy duty keel rollers that make boarding and off-boarding simple and smooth.

The EXTREME 24 Three-Piece Boat Port is 24 Feet long, 10 Feet wide and includes 1 Entrance Deck, 2 Main Decks, 8 Pin Connection Systems, 10 Bunk Rollers, 8 Heavy Duty Keel Rollers and 2 Keel Rests.

part# DF301980

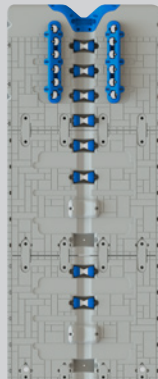

# GENESIS & EXTREME ACCESSORIES & ATTACHMENT KITS

## GENESIS TO WAVE DOCK ATTACHMENT KIT

part# DF301858

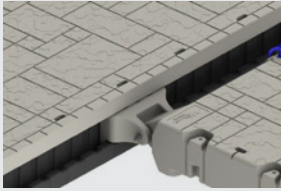

## GENESIS AND EXTREME EXTENSION BRACKETS TO WAVE DOCK

48" - 92"  
part# DF301363

24" - 42"  
part# DF301364

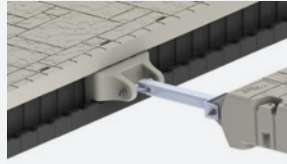

## GENESIS AND EXTREME BUOYANCY BOOSTER

part# DF301823



## GENESIS TO FLOATING DOCK ATTACHMENT KIT

part# DF301857

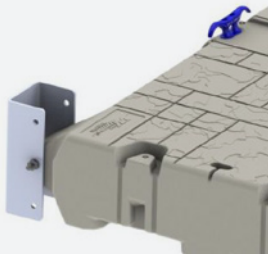

## EXTREME PIPE SLEEVES

2"  
part# DF301746

3"  
part# DF301747

4"  
part# DF301748

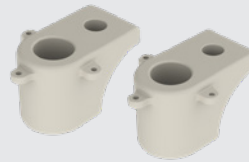

## EXTREME FRONT PLUG KIT (2)

part# DF301749

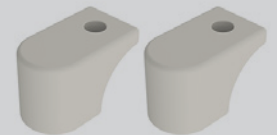

## GENESIS 2" POST ATTACHMENT KIT

part# DF301859



## EXTREME PIPE MOUNT TO FIXED DOCK

2" (24" - 42")  
part# DF301409

4" (24" - 42")  
part# DF301410

2" Raised  
part# DF301411

4" Raised  
part# DF301412

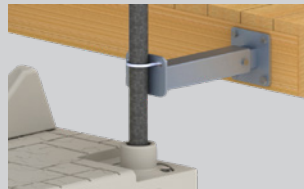

## EXTREME FLOATING DOCK KIT

part# DF301329

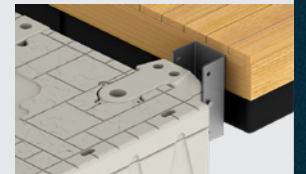

## EXTREME DIRECT CONNECT TO WAVE DOCK

part# DF301346

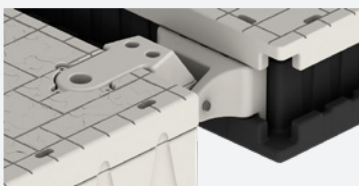



# WAVE DOCK

*Solid floats, easy assembly and a full line of accessories and components.*



## RESIDENTIAL AND COMMERCIAL FLOATING DOCK SYSTEM

Hewitt Wave Dock System is easy to assemble and infinitely modular, featuring paver-style textured decking, foam-core floats and a patented H-Beam Connection System. Simply put – Beautiful decks, solid floats, easy assembly and a full line of accessories and components.

- Rotational Molded Construction
- High-Impact Polyethylene
- Maximum UV Protection
- Flagstone Textured Deck Finish
- Foam-Filled Float w/ Suctioning Pockets
- H-Beam Connection System
- 3 Deck/Float Section Sizes
- 3 H-Beam Sizes
- Full Line of Integrating Accessories
- Integrating PWC Ports
- Unlimited Configurations

## WAVE DOCK DECK/FLOAT SECTIONS

Revolutionizing the way waterfront home owners and marinas customize their floating dock system, Wave Dock Deck/Float Sections feature an esthetically pleasing “Pebble Beach” textured Deck finish, bringing a rich new look and feel to the industry. Rotationally molded with high-impact polyethylene and maximum UV protection, the Wave Dock system is strategically designed for beauty and function.

## DECK/FLOAT SECTION SIZES

120" L x 40" W x 16" H | Weight: 250 lbs  
Weight Cap: 2,000 lbs **part# DF300445**

120" L x 60" W x 16" H | Weight: 350 lbs  
Weight Cap: 3,000 lbs **part# DF301937**

120" L X 60" W x 18.5" H Bridge Dock Section w/ Float  
Weight: 375 lbs | Weight Cap: 3000 lbs  
**part# DF301592**

60" L x 30" W x 16" H | Weight: 90 lbs  
Weight Cap: 600 lbs **part# DF300444**

60" L x 60" W x 16" H Dock Section w/ Float  
Weight: 200 lbs | Weight Cap: 1500 lbs  
**part# DF301894**

## H-BEAM KITS

24" H-Beam Kit (Pair) **part# DF300065**  
Connects two 60" x 120" deck sections end-to-end.

50" H-Beam Kit (Pair) **part# DF300067**  
Connects two 60" x 120" deck sections side-to-side (Recommended for permanent, year-round install).

31" H-Beam Kit (Pair) **part# DF301520**  
Connects two 40" x 120" deck sections end-to-end. Can also connect two 60" x 120" deck sections side-to-side. (Recommended for seasonal install.)

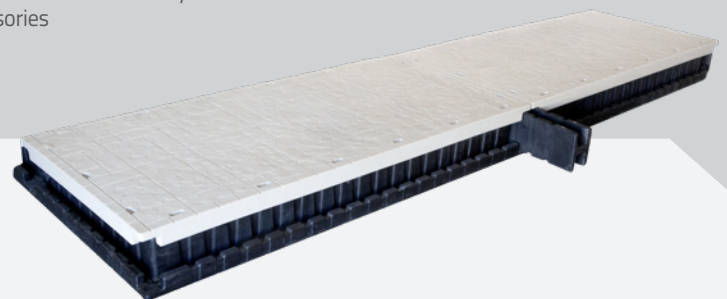

## Section Bottom (Float) With Suctioning Pockets

A foam-filled Float engineered with suctioning pockets that dramatically increase stability and keep your deck where you want it – on the water.



## Section Top (Deck) with H-Beam Channel-Lock Connection

Sections connect quickly and can be arranged in an infinite number of configurations. H-Beams simply slide into the molded channels on the sides or ends of each Wave Dock Deck/Float section.



# WAVE ARMOR DOCK ACCESSORIES

## DOCK WEDGE

Creates a 30-degree angle.

40"  
part# DF301091  
60"  
part# DF301090

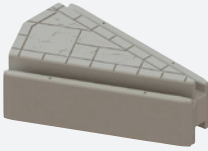

## KAYAK RACK

Stows two kayaks or canoes.  
part# DF300107



## PATIO CHAIR FOR WAVE DOCK

Powder-coated aluminum, adjustable swivel rocker mechanism. Chair is wrapped with two layers of fabric and is durable and comfortable. Optional bracket for mounting chair to dock.  
part# DPCHAIRW

## 30" PATIO TABLE FOR WAVE DOCK

Low-maintenance powder-coated aluminum mesh table. Includes hole for optional umbrella and optional bracket for mounting table to dock.  
part# DPTABLEW



Wave Dock Bracket  
part# DPBRKTW

*Mount patio chairs and table with ability to reposition chairs anytime. Aluminum bracket is powder-coated to match the table and chairs.*

## 60" HALF ROUND DOCK [2-PIECE]

part# DF301910

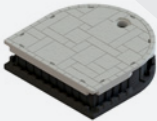

## 40" HALF ROUND DOCK

part# DF302055

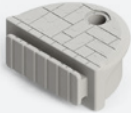

## 60" QUARTER ROUND DOCK [2-PIECE]

part# DF301841

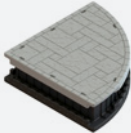

## GARBAGE CAN WITH LID

part# DF301775



## SMART STEPS KIT/ UNIVERSAL DOCK STEPS KIT

Includes two steps, t-plate, and mount.  
part# DF301809



## SMALL PLANTER/ FLOWER POT

part# DF301844



## LARGE PLANTER/ FLOWER POT

part# DF301776



## KAYAK ASSIST

Provides stability when launching or exiting kayaks and canoes. Mounts to Lower Step Down. Includes one rail and float.

Kayak Assist  
part# DF301246

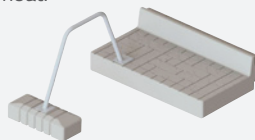

Step Down Only  
part# DF301096

Entire Kit  
part# DF301753

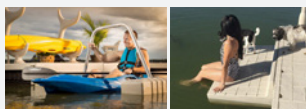

## CLEAT

Heavy-duty 8" Nylon Dock Cleat (2)  
part# DF301106



Wave Dock 10" Aluminum Dock Cleat (2)  
part# DF301779





# WAVE ARMOR DOCK ACCESSORIES

## HEXAGON SOLAR LIGHTS

Lights snap into the mounting pockets around the Wave Dock perimeter. Lights can also be utilized in the recessed pocket on top of the Heritage Post Covers. (Qty 2)  
**part# DF301126**

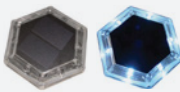

## WAVE DOCK POST COVER

Slides over post. Mounts to Attachment Kit sold separately.  
**part# DF301532**

With solar light pocket.  
**part# DF302132** (2pcs)  
**part# DF302133** (8pcs)



## DECORATIVE SNAP-IN PLUGS

(Qty 20)  
 For a clean, finished look.  
**part# DF301574**



## WAVE DOCK POST ATTACHMENT KIT (WITH 4" FLAT INSERT)

(With flat reducer bushing)  
 (Pair - 2 pcs)  
**part# DF301525**



## FLOATING DOCK LADDER

Folds up when not in use.  
**part# DF300081**



## WHEEL KIT

(Qty 2)  
 Aids in installing and removing sections.  
**part# DWHEEL**

Attaches to Universal H-Beam. Must purchase one.  
 7" **part# DF301529**  
 12" **part# DF301504**



## HAND RAILING

Single Handrail

5' **part# D1RAILCW5**  
 10' **part# D1RAILCW10**

Must purchase two universal H-beams per each handrail.  
**part# DF301529**



## 10" PYLON HOOP ATTACHMENT

(Qty 1)  
 10"  
**part# DF300106**



## DOCK RAMP WITH TAPERED END AND HINGE KIT

7' Long **part# DF300055**  
 12'8" Long **part# DF301518**

Custom sizes available.

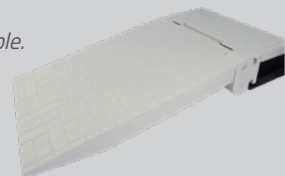

## HERITAGE DOCK POST COVER

Post covers are eloquently designed with molded-in through holes that accommodate rope up to 1-1/2" D. Covers feature a recessed pocket on top to secure Hexagon Solar Light.

Slides over post. (2 pcs)  
**part# DF301262**  
 Slides into H-beam. (2 pcs)  
**part# DF301278**



## RAMP ABUTMENT

7' Long **part# DF301509**  
 12'8" Long **part# DF301661**

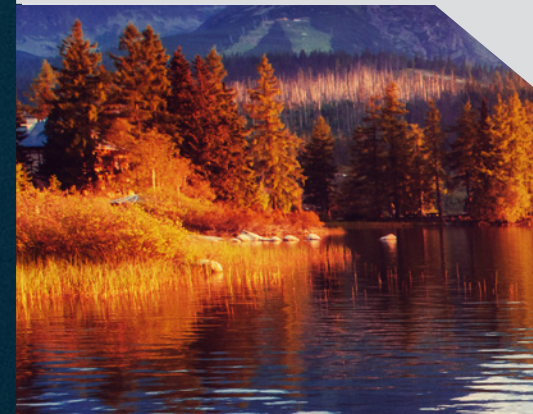

*It is recommended that the rub rail of your boat comes in contact with the bumper rather than the bumper to come in contact with the sides of your boat as this can result in serious damage to the sides of your boat*

## Customize your floating dock with a wide range of accessories.

### DOCK LOCKER BOX

High-impact molded polyethylene and UV protection. Pebble Beach Textured Finish. (Fits 5' Bench only)  
Storage Box **part# DF301093**

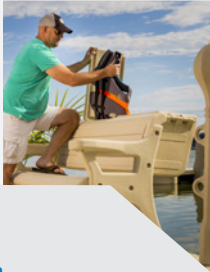

### WAVE DOCK POST ATTACHMENT KIT (RAISED INSERT)

With 2" raised bushing. (Pair - 2pcs)  
**part# DF301523**



### DOCK BENCH ATTACHMENT SYSTEM

Places the bench over the water.  
**part# DF300963**



### UNIVERSAL H-BEAM T-PLATE CONNECTOR

Connector secures personalized accessories. (2pcs)



7"  
**part# DF301529**  
12"  
**part# DF301504**

### MOORING CHAIN ADAPTOR

For 3/8" and 1/2" chain. Mounts to post attachment kits.  
**part# DF21926**



### UNIVERSAL DOCK & PATIO BENCH

4' Bench:  
52"W x 37"H x 27"D. 66 lbs.  
**part# DF300014**  
5' Bench:  
64"W x 37"H x 27"D. 81 lbs.  
**part# DF301092**  
6' Bench:  
76"W x 37"H x 27"D. 96 lbs.  
**part# DF300016**



### 5" FILLER (DECORATIVE SIDE PANEL)

Creates a finished look. (8 pcs)  
**part# DF301530**

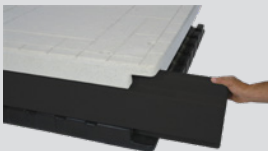

### WINCH MOORING ADAPTOR

Mounts to post attachment kit. Winch and handle sold separately.  
**part# DF21925**



### CORNERS

Adds to your surface area.

30" Corner Deck Section  
**part# DF300051**  
60" Corner Deck Section  
**part# DF301577**

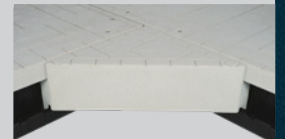

### 36" VINYL BUMPER

Adjustable in height.  
**part# D1BUVV**

*Includes universal H-beam.*



### WAVE DOCK BUMPERS

15.5"H x 9.5"D (Vertical)  
4" above dock.  
**part# DF301103**



### VERTICAL DOCK BUMPERS

10"W x 15.5"D x 34"H (Medium) Extends 17" above dock surface.  
**part# DF300974**  
10"W x 15.5"D x 44"H (Large) Extends 27" above dock surface.  
**part# DF300975**



### SLIM DOCK BUMPER

Vertical **part# DF301511**  
Horizontal **part# DF301351**

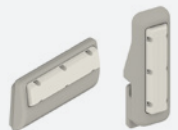



# OTTER ISLAND RAFTS



## OTTER ISLAND

Kids and adults alike will love taking a mini-vacation on this large water and swim raft. Two adjustable backrests lay flat and completely integrate with the deck when not in use.

8'W x 10'L  
3,000 lb Weight Capacity  
300 lb Raft Weight

Three Colors:  
Beige Body/Green Accents  
**part# D1PSRB**  
Yellow Body/Blue Accents  
**part# D1PSRY**  
Yellow Body/Green Accents  
**part# D1PSRYG**

- Storage space beneath seat backs
- Flip-up aluminum ladder for easy storage
- Non-slip surface
- Molded handles & rope hitches around entire raft bottom
- Recessed reflectors on all sides
- 100% weatherproof polyethylene construction
- Adjustable seat backs sit up or lay flat
- Rounded corners & pontoon-style bottom
- Pop-up table with beverage holders





### OTTER ISLAND SEAT CUSHIONS

Cushions fit over the back rests.  
(Qty 2)  
part# DF301545

### BIRD DETERRENT

Attaches to raft and will keep birds away and your raft clean. Removable when raft is in use.

part# DBIRD

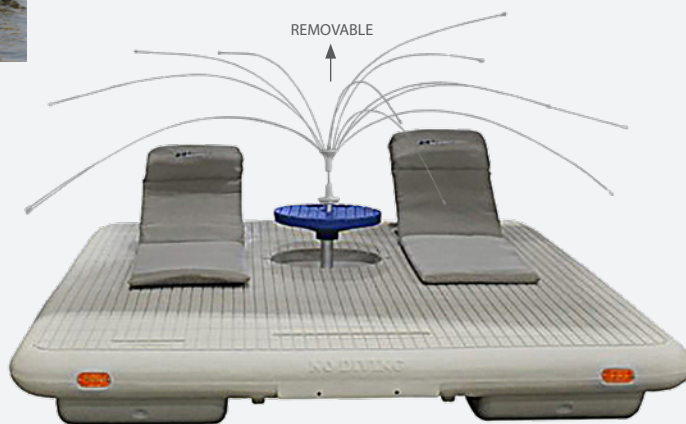

### PROTECTIVE COVER

Cover protects swim raft and ladder during off-season storage.

part# DF300050



### DOUBLE CLEVIS KIT

Kit is designed for quick, easy attachment of an anchor to your swim raft using rope or chain. The kit includes two 32" lengths of galvanized chain with a clevis at each end for attachment to the raft's eyelets. Two sections of stretch rope are provided as a flexible link that hooks between the eyelet at the center of the clevis chain and your anchor rope or chain.

Double Kit part# DF300474  
Volume Pack 6 pcs

Clevis Only part# DF301547



### RAFT ANCHOR

Made of 100% high-density polyethylene. Fill it with sand and this 140 lb anchor will keep your raft in place.

Anchor part# DF300003

Volume Pack 6 pcs





# DOCK GATES & MAT RACK

All-aluminum gate can be mounted to end of dock, gangways or ramps.  
Special widths available. Includes latch and key.

## SECURITY GATE

4' Security Gate  
part# DGATES4

6' Security Gate  
part# DGATES6

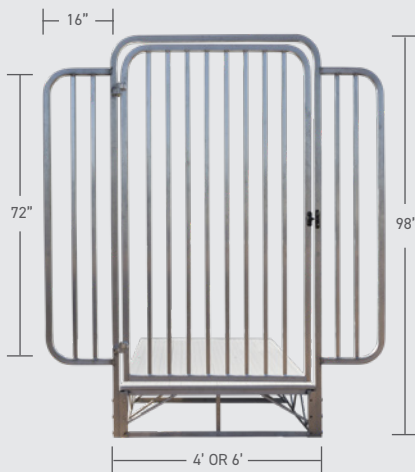

## ACCESS GATE

4' Access Gate  
part# DGATEA4

6' Access Gate  
part# DGATEA6

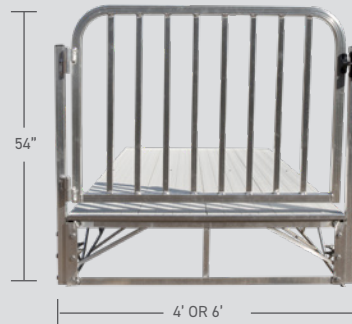

## MAT RACK

1-1/2" x 1-1/2" aluminum rack stores your water mat. Includes tension cords and fits dockside tubes up to 1-1/4"

part# D1MAT



BRACKET FITS  
1-1/4" TUBE



TENSION  
CORD

# BUNK TREADS & CARPET

## 7" TRAILER JACK STAND DONUT

Keep your trailer jack from sinking into the ground or moving.

Marine-grade PVC.

Trailer Jack Stand Donut

part# **D1BJD**

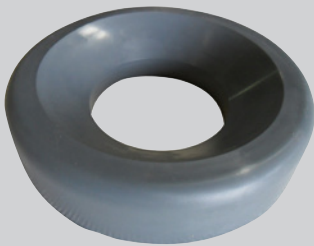

## REPLACEMENT CARPET

Heavy-duty all-weather carpet with thick backing is designed to replace worn and frayed bunks. The marine-grade carpet will not rot or mildew. UV fade and fray resistant. One of the strongest on the market!

Weight: 14 oz. per square yard

Material: Interlocked Polypropylene Fibers

Backing: 10 oz. Marine Back

11" x 30' for two 14'  
16" x 30' for two 14'  
20" x 30' for two 14'  
26" x 30' for two 14'

1" x 4"  
2" x 6"  
guides  
2" x 10"

part# **LCARPETV**  
part# **LCARPETB**  
part# **LCARPETG**  
part# **LCARPETBL**



## BUNK GLIDE ON

Slide easily on or off. Self Centering and constructed with enhanced PVC. For painted, fiberglass or aluminum boats. Fits Standard bunk boards. (Includes mounting screws.)

2"x6" - Four 13" end caps, Four 36" middles

White 2" x 6" Glide On part# **D1BG26WE**

Black 2" x 6" Glide On part# **D1BG26BK**

2"x4" - Four 50" pieces

White 2" x 4" Glide On part# **D1BG24WE**

Black 2" x 4" Glide On part# **D1BG24BK**



## BUNK TREADS

Make sliding on or off easy. Treads screw directly onto carpeted bunk boards. Screws included. Fits 2" x 6" or 2" x 4" standard bunk boards. 10 pcs 3" x 16"

Treads

part# **D1BBT**

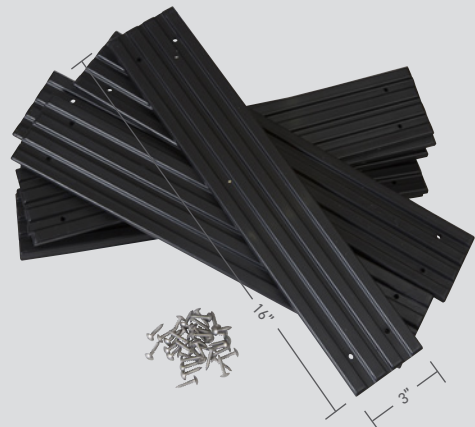



# CENTERING GUIDES

*Help your boat into the lift with centering guides.*

## 30" PLASTIC PONTOON GUIDES FOR CANTILEVER LIFTS AND PWC LIFTS

Guides feature shock absorbing rubber bushings and 24" plastic bumpers.

White (one pair)

part# **LCGBPP**



## 36" PLASTIC CENTERING GUIDES

Guides feature shock absorbing rubber bushings and plastic bumpers.

Standard fits up to 3" wide by 3" tall beds

White (one pair)

part# **LCGBP**

Hi-Lifter fits up to 3" wide by 5" tall beds

White (one pair)

part# **LCGBPHL**

Proteus

White (one pair)

part# **LCGBPPO**

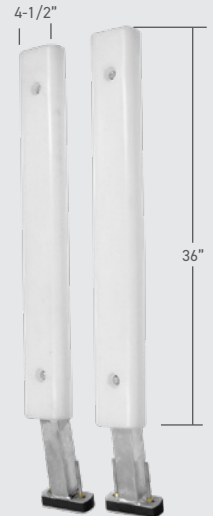

**Everything you need  
to keep your  
waterfront lifestyle  
running smoothly.**

## HEAVY-DUTY CENTERING GUIDES

Heavy-duty centering guides feature shock absorbing springs and plastic bumpers. Fits tubes up to 3-3/4" w x 8" h.

Guides (one pair)

part# **LCGBHD**

Tall Guides (one pair)

Adds 24" to height, 111" total height.

part# **LCGBHDL**

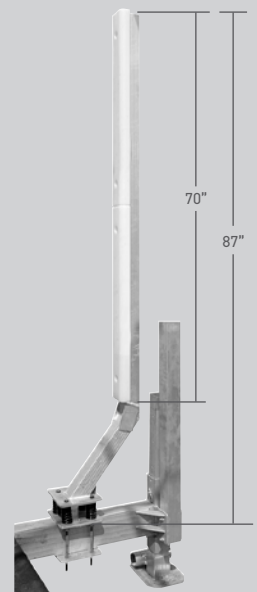

# LIFT ACCESSORIES

## LARGE ALUMINUM PAD

Provides leveling legs with greater support in soft or sandy lake bottoms.

Installs to bottom of existing pad. Drilling required for installation.

Pad **part# LLPAD**



## CATWALK

Aluminum brackets with mounting hardware, to make side mounted catwalk for cantilever and hydraulic lifts with canopy or free standing canopies (planks not included).

Kit fits up to 3"x3" tube.

One Pair  
**part# LCWB**

Hi-Lift Vertical Lift  
One Pair  
**part# LCWBHL**

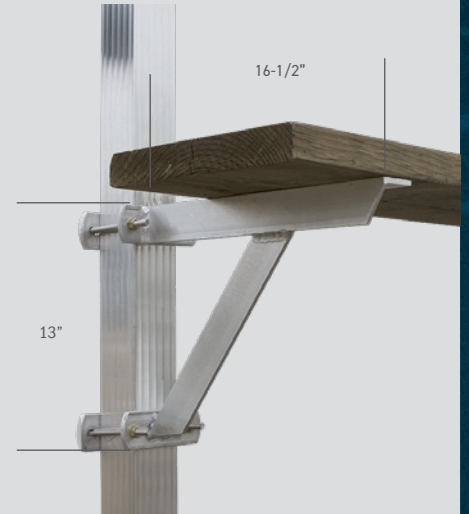

## LIFT EASE

Boatlift adjustable screw wheel kit features a full length mounting extrusion and is attached to the lift in two locations. Built in tire brake helps avoid tire rotation when the wheel is not touching the ground. 20-1/2" of adjustment. 27" wheel standard, optional 18" wheel available.

**part# LWKE**

Exchange 27" wheel for 18" wheel.  
**part# DWHEELSX**

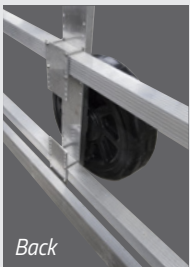



# ELECTRIC HOISTS

*A powerful alternative to the manual winch.*

## LIFT BOSS DIRECT DRIVE

The Lift Boss Boat Lift Direct Drive System takes the place of the standard winch wheel. It features remote control operation and dock lighting. Available in AC and DC versions for use on lifts up to 6000 lb lifting capacity. Unit includes a two-piece cover.

Motor	RPM	Current Draw	Part #
AC 110V Unit w/Remote	56	7-16 AMPS	<b>LWHDD110</b>
AC 110V Unit w/Key Switch	60	9-11 AMPS	<b>LWHDDS110</b>
DC 12V/24V Unit w/Remote	58 at 12V 96 at 24V	40-80 AMPS at 12V 20-40 AMPS at 24V	<b>LWHDD12</b>
DC 12V/24V Unit w/Key Switch	58 at 12V 96 at 24V	40-80 AMPS at 12V 20-40 AMPS at 24V	<b>LWHDDS12</b>

Optional Jumper Wire needed to run motor (24V)  
**part# NAHYBC18**

Installation Kits  
Beach King  
Daka Lifts  
Dock Rite  
Dutton-Lainson B1200, 1500, 2500 (Lorenz winch)  
Flo inc (Open Face winch)  
Fulton  
Harbormaster  
Hewitt  
Lakeside Lift (Lorenz winch)  
Porta-Dock  
RGC  
ShoreMaster  
Shorestation (Up to 4000)  
Shorestation (Up to 6000)

**part# LWHDDK-L**  
**part# LWHDDK-L**  
**part# LWHDDK-L**  
**part# LWHDDK-DL**  
**part# LWHDDK-L**  
**part# LWHDDK-L**  
**part# LWHDDK-F**  
**part# LWHDDK-HM**  
**part# LWHDDK-H**  
**part# LWHDDK-L**  
**part# LWHDDK-PD**  
**part# LWHDDK-RGC**  
**part# LWHDDK-SM**  
**part# LWHDDK-SS4**  
**part# LWHDDK-SS6**

## LIMIT SWITCH

Mechanical spring driven limit switch prevents you from overlifting your boat on lift. AC/DC Models with remote ONLY!

Lift Boss **part# LWHDDL**      Shore Commander, Rail, Proteus **part# LWHDDSS**



## 10' BATTERY EXTENSION

**part# LWHddb10**



## LIFT BOSS LED LIGHT

**part# LWHDDK-LIGHT**



## LIFT BOSS PENDANT

**part# LWHDDPEN**



## BUCK BOOSTER

Used when electrical wiring is inadequate or if faster lifting time is desired with the AC Turnkey. AC Models ONLY!

Buck Booster  
**part# LWHddb**



## INTEGRATED HOIST

All-in-one winch and motor available in:  
AC with remote  
DC with remote

5,000lb  
AC **part# LWIWAC**  
DC **part# LWIWDC**

7,500lb for 5/16" Cable  
AC **part# LWIWAC516**  
DC **part# LWIWDC516**

7,500lb for 3/8" Cable  
AC **part# LWIWAC38**  
DC **part# LWIWDC38**



# SOLAR PANELS & BATTERY STANDS

*Efficiently charge your battery even in cloudy conditions.*

## SOLAR PANEL BATTERY CHARGER

10 watt & 20 watt solar panels. Charger keeps your marine battery charged without overcharging.

10 Watt Dimensions: 13-1/2" x 11"  
 20 Watt Dimensions: 24-1/2" x 11"  
 30 Watt Dimensions: 23-1/4" x 17-3/4"

10 Watt 12V Solar Panel Package (Includes Solar Panel, Stand and Status Indicator and Charge Regulator)  
**part# LSPP10**

10 Watt 12V Solar Panel Only  
**part# LSP10**

20 Watt 12V Solar Panel Package (Includes Solar Panel, Stand, Status Indicator and Charge Regulator)  
**part# LSPP20**

20 Watt 12V Solar Panel Only  
**part# LSP20**

30 Watt 12V Solar Panel Package (Includes Panel, Stand, Charge Controller With Built In Battery Indicator)  
**part# LSPP12-30**

40 Watt 24V Solar Panel Package (Includes Panel, Stand, Charge Controller With Built In Battery Indicator)  
**part# LSPP40**

30 Watt 24 V Solar Panel Package (Includes Solar Panel, Stand, 2-Status Indicator and Charge Regulator)  
**part# LSPP30**

Status Indicator  
**part# LSPSB**

Stand Only  
**part# LSPS10**



## BATTERY BOX STAND

Keeps your marine batteries off your dock and out of the way.

12V Stand  
 Clamps to square or round tube.  
 Stand  
**part# L1HYBBS**

24V Stand  
 Bolts on, drilling required.  
 Stand  
**part# L1HYBBS24**



## KILL A WATT

Plug in Kill A Watt to check the quality of the electrical power provided from your utility company, by monitoring voltage, live frequency and power factor. Helps detect voltage drops and brownout conditions before they damage equipment.

Meter  
**part# LWMETER**





# FLOAT TANKS

Volume Pack any 25 floats

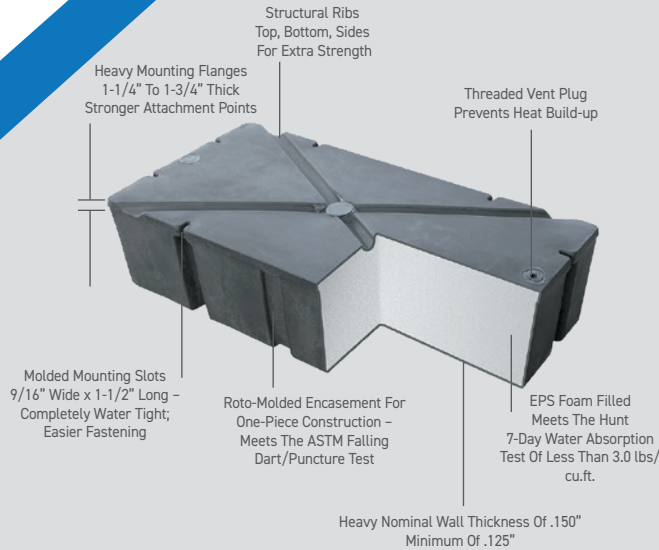

## FLOAT TANKS

Used to construct a floating dock or raft. Also useful for adding sections to an existing dock. 62 sizes available. What you can't see is vital to the performance of our floating docks! Unarguably the most sought after floats (based on sales volume) in the marina market are from Premier, because they meet ALL of the important design, engineering, manufacturing, shipping, storage and installation standards that give you the best performance and value. One piece molded rotational drum: Foam filled, molded in mounting slots, heavy-duty mounting flanges, air relief vent, 8 year limited warranty (non-prorated).

## LAG BOLT SET FOR WOOD

Attach flotation drums to dock system.

- 3/8" x 2" galvanized lag bolt
- 3/8" x 3" galvanized lag bolt
- 3/8" x 5" galvanized lag bolt
- 3/8" SS flat washer

- part# NB382L
- part# NB383L
- part# NB385L
- part# NW38FL

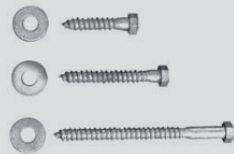

Model	Size (Inches)	Cu. Ft.	Wt. (lbs)	Float Buoy.
Series 1248				
part# DFT1248-20	12" x 48" x 20"	6.7	27	359
Series 1848				
part# DFT1848-36	18" x 48" x 36"	18	54	966
Series 2072				
part# DFT2072-08	20" x 72" x 8"	6.7	34	360
part# DFT2072-10	20" x 72" x 10"	8.3	38	450
Series 2096				
part# DFT2096-10	20" x 96" x 10"	11.1	50	592

### Series 2436

part# DFT2436-08	24" x 36" x 8"	4	21	211
part# DFT2436-12	24" x 36" x 12"	6	27	318
part# DFT2436-16	24" x 36" x 16"	8	30	436
part# DFT2436-20	24" x 36" x 20"	10	33	540

### Series 2448

part# DFT2448-08	24" x 48" x 8"	5.3	27	288
part# DFT2448-12	24" x 48" x 12"	8	33	433
part# DFT2448-16	24" x 48" x 16"	10.7	39	581
part# DFT2448-20	24" x 48" x 20"	13.3	44	729
part# DFT2448-24	24" x 48" x 24"	16	50	866
part# DFT2448-36	24" x 48" x 36"	24	72	1297

### Series 2472

part# DFT2472-12	24" x 72" x 12"	12	44	629
part# DFT2472-16	24" x 72" x 16"	16	57	796

### Series 2496

part# DFT2496-08	24" x 96" x 8"	10.7	53	562
part# DFT2496-12	24" x 96" x 12"	16	64	866
part# DFT2496-16	24" x 96" x 16"	21.3	75	1155
part# DFT2496-20	24" x 96" x 20"	26.7	84	1420

### Series 3242

part# DFT3242-18	32" x 42" x 18"	14.2	46	790
------------------	-----------------	------	----	-----

### Series 3648

part# DFT3648-08	36" x 48" x 8"	8	37	429
part# DFT3648-12	36" x 48" x 12"	12	45	650
part# DFT3648-16	36" x 48" x 16"	16	51	874
part# DFT3648-18	36" x 48" x 18"	18	54	990
part# DFT3648-20	36" x 48" x 20"	20	62	1088
part# DFT3648-24	36" x 48" x 24"	24	66	1280
part# DFT3648-32	36" x 48" x 32"	32	82	1644

### Series 3660

part# DFT3660-12	36" x 60" x 12"	15	58	783
part# DFT3660-16	36" x 60" x 16"	20	61	1017
part# DFT3660-20	36" x 60" x 20"	25	74	1328

### Series 3672

part# DFT3672-12	36" x 72" x 12"	18	62	999
part# DFT3672-16	36" x 72" x 16"	24	78	1313
part# DFT3672-20	36" x 72" x 20"	30	87	1638
part# DFT3672-24	36" x 72" x 24"	36	99	1951
part# DFT3672-32	36" x 72" x 32"	48	120	2553

### Series 3696

part# DFT3696-12	36" x 96" x 12"	24	90	1331
part# DFT3696-16	36" x 96" x 16"	32	103	1735
part# DFT3696-20	36" x 96" x 20"	40	112	2172
part# DFT3696-24	36" x 96" x 24"	48	132	2597
part# DFT3696-32	36" x 96" x 32"	64	149	3349

### Series 3878

part# DFT3878-12	38" x 78" x 12"	20.6	76	1133
------------------	-----------------	------	----	------

### Series 4272

part# DFT4272-12	42" x 72" x 12"	21	80	1166
part# DFT4272-16	42" x 72" x 16"	28	86	1555
part# DFT4272-20	42" x 72" x 20"	35	98	1934

### Series 4848

part# DFT4848-12	48" x 48" x 12"	16	55	878
part# DFT4848-16	48" x 48" x 16"	21.3	67	1182
part# DFT4848-20	48" x 48" x 20"	26.7	77	1480
part# DFT4848-24	48" x 48" x 24"	32	86	1738
part# DFT4848-32	48" x 48" x 32"	42.7	108	2231
part# DFT4848-36	48" x 48" x 36"	48	114	2480



*The most sought-after floats on the market.*



Series 4860

<b>part# DFT4860-12</b>	48" x 60" x 12"	20	73	1101
<b>part# DFT4860-16</b>	48" x 60" x 16"	26.7	80	1497
<b>part# DFT4860-20</b>	48" x 60" x 20"	33.3	92	1851
<b>part# DFT4860-24</b>	48" x 60" x 24"	40	106	2199
<b>part# DFT4860-32</b>	48" x 60" x 32"	53.3	130	2815

Series 4872

<b>part# DFT4872-12</b>	48" x 72" x 12"	24	78	1369
<b>part# DFT4872-16</b>	48" x 72" x 16"	32	98	1823
<b>part# DFT4872-20</b>	48" x 72" x 20"	40	111	2225
<b>part# DFT4872-24</b>	48" x 72" x 24"	48	123	2701
<b>part# DFT4872-28</b>	48" x 72" x 28"	56	141	2940
<b>part# DFT4872-32</b>	48" x 72" x 32"	64	154	3457
<b>part# DFT4872-36</b>	48" x 72" x 36"	72	166	3800

Series 4884

<b>part# DFT4884-12</b>	48" x 84" x 12"	28	89	1510
<b>part# DFT4884-16</b>	48" x 84" x 16"	37.3	105	2056

Series 4896

<b>part# DFT4896-12</b>	48" x 96" x 12"	32	109	1803
<b>part# DFT4896-16</b>	48" x 96" x 16"	42.7	131	2396
<b>part# DFT4896-20</b>	48" x 96" x 20"	53.3	145	2996
<b>part# DFT4896-24</b>	48" x 96" x 24"	64	163	3578
<b>part# DFT4896-32</b>	48" x 96" x 32"	85.3	193	4631

Series 48120

<b>part# DFT48120-12</b>	48" x 120" x 12"	40	124	2118
<b>part# DFT48120-16</b>	48" x 120" x 16"	53.3	143	3020
<b>part# DFT48120-20</b>	48" x 120" x 20"	66.7	177	3692

Boat Lift Series (All .375 Wall Thickness)

<b>part# DFT252 BLAT</b>	26" x 30" x 60"	27	85	1000
<b>part# DFT183 BLAT</b>	30" x 30" x 90"	46.9	130	2000
<b>part# DFT242 BLAT</b>	32" x 40" x 108"	81.5	200	3700



# THRUFLOW™ DECKING

## THRUFLOW™

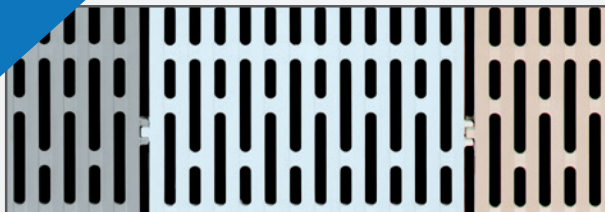

GRAY

WHITE

BEIGE

The complete flooring system for docks, decks, marinas, gangways and walkways. Easy to assemble, maintenance-free and long-lasting.

ThruFlow™ is designed and engineered to be the finished decking surface for docks, decks, walkways and virtually any indoor or outdoor structure. ThruFlow™ panels are the ideal choice for: Docks and piers, decks and patios, marinas, walkways, gangways and ramps, any area prone to storm effects, or environmental sensitivity.

### Safety First

Proprietary molded-in 360 degree non-slip surface makes ThruFlow™ safe for children and always comfortable on the floor. ThruFlow™ also has complete fresh and saltwater tolerance.

### Environmentally Friendly

A grated design allows for maximum light penetration; protecting sensitive sea grasses and marine life. Total open area amounts to 43%.

### Maintenance-free

As a non-microbial product, ThruFlow™ does not allow for any leaching, rot, mildew or insect growth. There is absolutely no treatment required.

### Durable

Not only does ThruFlow™ have unparalleled strength, but its open design minimizes the lifting effects that waves and storm surge have on your dock. Survive the storm with ThruFlow™.

## THRUFLOW™ DECKING

Color	Size	Part #	Volume	Mounting Holes
White	1x3	part# D1DTF3X1	Volume 140	6
	1x4	part# D1DTF4X1	Volume 140	8
	1x5	part# D1DTF5X1	Volume 140	10
	4x4	part# D1DTF4X4	Volume 35	32
Beige	1x3	part# D1DTFB3X1	Volume 140	6
	1x4	part# D1DTFB4X1	Volume 140	8
	1x5	part# D1DTFB5X1	Volume 140	10
	4x4	part# D1DTFB4X4	Volume 35	32
Gray	1x3	part# D1DTFG3X1	Volume 140	6
	1x4	part# D1DTFG4X1	Volume 140	8
	1x5	part# D1DTFG5X1	Volume 140	10
	4x4	part# D1DTFG4X4	Volume 35	32

## THRUFLOW™ SELF-TAPPING SCREWS

High-quality screws fasten with a large .455" head. Ideal for aluminum frames.

Stainless Steel Screws for Aluminum Frames

One each **part# NS10134FH**

Volume Pack 200 pcs

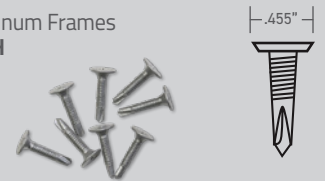

Coated Screws for Steel Frames

One each **part# NS102FHS**

Volume Pack 200 pcs



Stainless Steel Screws for Wood Frames

One each **part# NS102PH**

Volume Pack 200 pcs

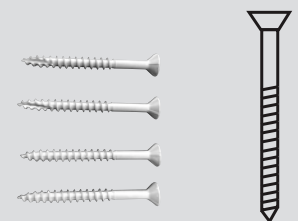

# DOCK HARDWARE

## UNIDOCK CLAMP

Used for connecting Ultra, Northern Lights, Judge, and Floe dock sections together.

Clamp  
part# DUCLAMP

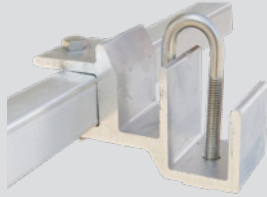

## ULTRA PIPE BRACKETS

Heavy-duty pipe brackets for Ultra, Northern Lights, Judge, and Floe docks.

Standard - for 1-1/4" Pipe  
part# DUBRAC

Medium - for 1-1/2" Pipe  
part# DUBRACM

Large - for 2" Pipe  
part# DUBRACL

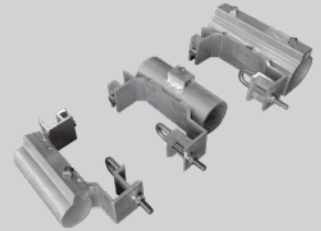

## DOCK HARDWARE

Commercial-grade (1/4") dock hardware is designed for use with 1-1/2" thick lumber (minimum width 6"). All hardware is mounted with 3/8" carriage bolts. All male and female dock to dock connections are made with either 3/4" bolts with lock nuts or 3/4" connecting pins.

**Wood Dock Plan Kit** will show you the basics on building a lightweight and long-lasting floating dock system.

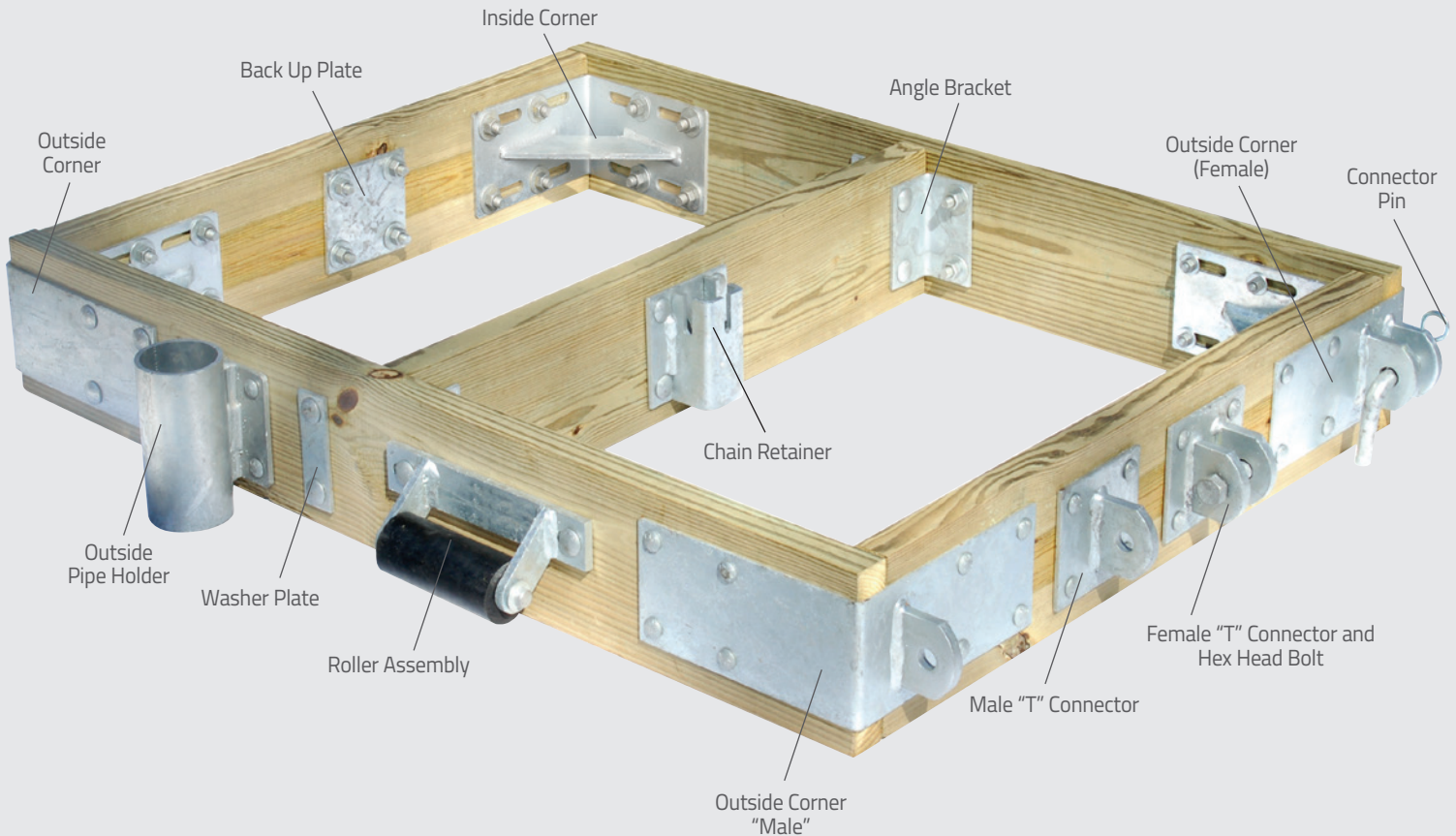



# GALVANIZED DOCK HARDWARE

## LAG BOLT SET

Attach flotation drums to dock system.

3/8" x 2" galvanized lag bolt  
 3/8" x 3" galvanized lag bolt  
 3/8" x 5" galvanized lag bolt  
 3/8" SS flat washer

part# NB382L  
 part# NB383L  
 part# NB385L  
 part# NW38FL

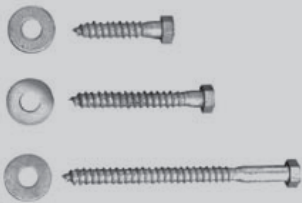

## CARRIAGE BOLT SET

Includes bolt, flat washer and nut.

3/8" x 2-1/2" SS Carriage Bolt  
 3/8" SS Flat Washer  
 3/8" Brass Nut

part# NB38212C  
 part# NW38FL  
 part# NN38S

1/2" x 3" "M" SS Carriage Bolt  
 1/2" SS Flat Washer  
 1/2" Coated Nut

part# NB123C  
 part# NW12FL  
 part# NN12S

3/4" x 3-1/2" "N" SS Hex Bolt  
 3/4" SS Flat Washer  
 3/4" Coated Nut

part# NB34312G  
 part# NW34FL  
 part# NN34L



## CONNECTOR PIN SET "O"

For quick disconnect. Used to connect male and female T connectors.

Volume Pack 24 pcs

3/4" Connector Pin & Hitch Clip Pin

part# DH26531

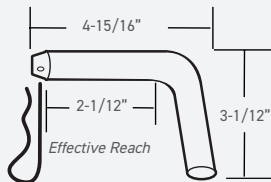

## INSIDE CORNER "D"

Heavy-duty inside corner should be used with an outside corner.

Volume Pack 16 pcs

Inside Corner "D" part# DH26403

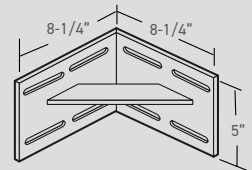

## ALUMINUM TRANSITION PLATE

Create a smooth transition between dock sections or seawall.

4' part# D1TP4  
 6' part# D1TP6  
 8' part# D1TP8  
 12' part# D1TP12

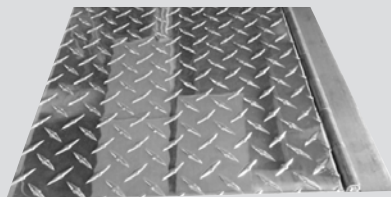

## HEAVY-DUTY ALUMINUM TRANSITION PLATE

With replaceable wear guard.

4' part# D1TPHD4  
 5' part# D1TPHD5  
 6' part# D1TPHD6  
 8' part# D1TPHD8

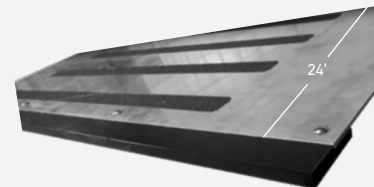

Weld hinge to your ramp/gangway, dock or seawall.  
 part # ADD-00114



3/4" x 7" SS Hex Bolt part # NB347G  
 3/4" Coated Hex Lock Nut part # NN34L  
 (Three are used on each plate.)

Commercial-grade (1/4") dock hardware is designed for use with 1-1/2" thick lumber (minimum width 6"). All hardware is mounted with 3/8" carriage bolts. All male and female dock to dock connections are made with either 3/4" bolts with lock nuts or 3/4" connecting pins.

### HEAVY-DUTY ROLLER ASSEMBLY "T"

Assist vertical motion of the dock in tidal action areas. 6" roller, 3/8" bracket.

HD Roller Assembly "T"  
Replacement Roller Only

part# DH26414  
part# DH48939

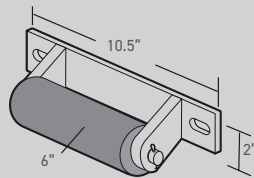
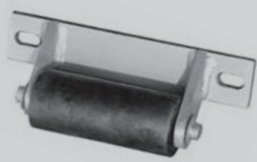

### OUTSIDE CORNER END "C"

Use at ends of fingers and docks. Ideal for swim floats.

Each Leg Is 10" L x 5" H.

Outside Corner End "C"  
Volume Pack 12 pcs

part# DH26402

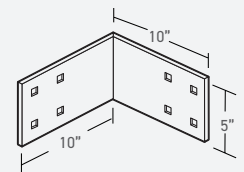

### INSIDE ROLLING RAMP BRACKET

Includes left and right ramp brackets. 5"x11" x 1/4"

Inside Rolling Ramp Bracket  
Replacement Roller Only

part# DH26431  
part# DH48939

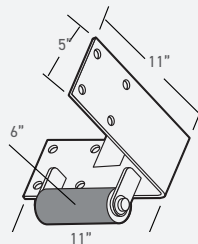

### INSIDE CORNER/ 3" PIPE HOLDER "E"

Use with one of the outside corners and as an internal pipe holder for dock frame strength.

8-1/2" L x 5" H.

3" Pipe Holder "E"  
Volume Pack 8 pcs

part# DH26404

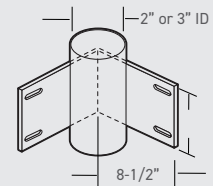
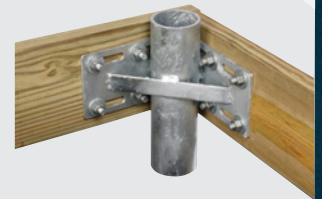

### PIPE HOLDER/ 3" OUTSIDE "K"

Bolts to outside of dock. Use 2" pipe to hold dock in place.

Pipe Holder  
Volume Pack 12 pcs

part# DH26411

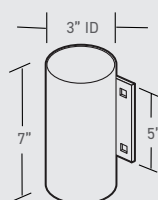

### INSIDE CORNER/ 2" PIPE HOLDER "E"

Use with one of the outside corners and as an internal pipe holder for dock frame strength.

8-1/2" L x 5" H.

2" Pipe Holder "E"  
Volume Pack 8 pcs

part# DH26405

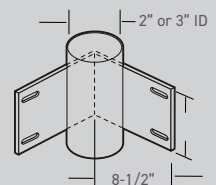
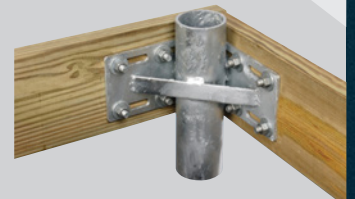



# GALVANIZED DOCK HARDWARE

## MALE T CONNECTOR "H"

Welded 1/2" Tab. Use with female T connector to attach fingers and ramps.

Male T Connector "H" part# DH26408

Volume Pack 12 pcs

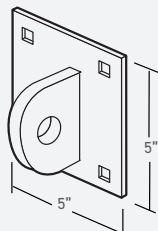

## WASHER PLATE "I"

Use two washer plates with each angle.

Washer Plate part# DH26409

Volume Pack 25 pcs

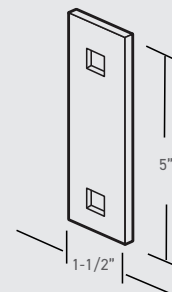

## CLEAT ANGLE

Slots accommodate various cleat sizes.

Cleat Angle part# DH26422

Volume Pack 24 pcs

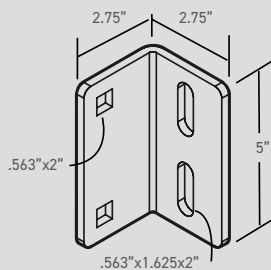

## FEMALE T CONNECTOR "G"

Two welded 1/2" tabs. Bolts to side of dock to attach fingers and ramps.

Female T Connector "G" part# DH26407

Volume Pack 12 pcs

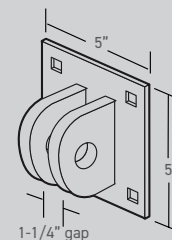
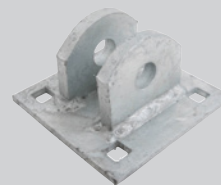

## BACK-UP PLATES "Q"

Use 5" x 5" reinforcing plates to back up Single T Males and Females.

Back-Up Plate "Q" part# DH26413

Volume Pack 20 pcs

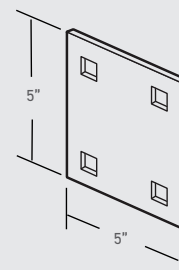

*Our Heavy-duty hardware provides exceptional strength and value.*

### ANGLE "F"

Heavy-Duty angle for cross supports.

Angle "F" **part# DH26406**

Volume Pack 24 pcs

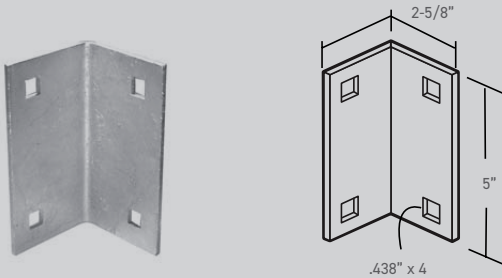

### CHAIN RETAINER "J"

Use weights and chains to hold dock in place. Accommodates 1/4", 3/8", & 1/2" Chain. 5" L x 5" H.

Chain Retainer "J" **part# DH26410**

Volume Pack 12 pcs

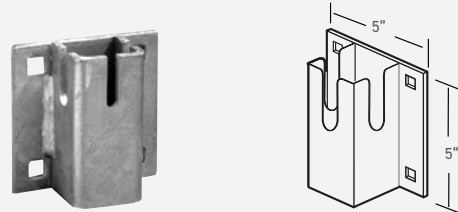

### OUTSIDE CORNER (FEMALE) "A"

Two 1/2" welded tabs. Use with a male outside corner.

Each Leg 10"L x 5"H.

Outside Corner (Female) "A" **part# DH26400**

Volume Pack 12 pcs

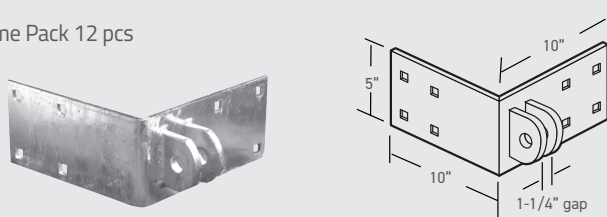

### OUTSIDE CORNER (MALE) "B"

1/2" welded tab. Use with a female outside corner to connect docks end to end.

Each leg 10"L x 5" H.

Outside Corner (Male) "B" **part# DH25491**

Volume Pack 12 pcs

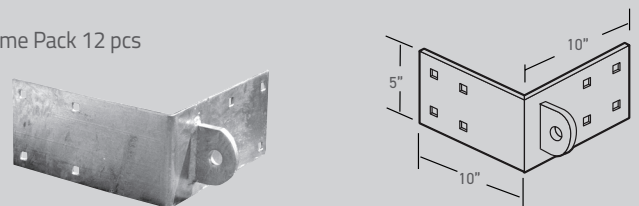

### DOCK PACKAGES

Dock planning made easy with our Dock Hardware Planning Guides.

Dock Hardware Planning Guide in PDF format available for download at [gmarineproducts.com](http://gmarineproducts.com).

PDF Planning Guides

- 10'x20' Wood Main Dock
- 8'x20' Wood Main Dock
- 4'x20' Wood Main Dock
- 6'x20' Wood Main Dock
- Typical U-Dock
- 3'x20' Wood Finger Dock
- 12'x12' Wood Swim Float
- 10'x10' Wood Swim Float
- Main Dock Decking

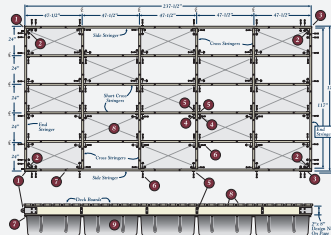

3'x20' Wood Finger Dock

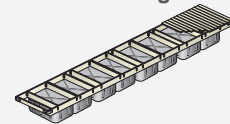

8'x20' Wood Main Dock

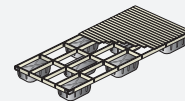

10'x20' Wood Main Dock

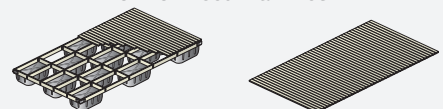



# PILING RINGS & CAPS



**Heavy-Duty, Saltwater Resistant, Large Sizes. Big or Small We've Got it All.**

## PILING RINGS WITH FOUR ROLLERS AND REMOVABLE END

8" Dock pile ring (10" opening)  
**part# DABPR8**  
 Volume Pack 6 pcs

10" Dock pile ring (12" opening)  
**part# DABPR10**  
 Volume Pack 6 pcs

12" Dock pile ring (14" opening)  
**part# DABPR12**  
 Volume Pack 6 pcs

Custom Dock pile ring  
 (made to your size)  
**part# DABPR**

Replacement Roller Only  
 5" long, 3-1/4" OD, 3/4" center  
**part# BPR-99543-005.000H**

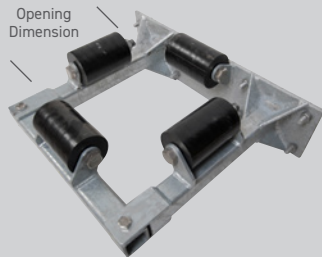

## 14" INTERIOR PILE GUIDE

14" clearance for square or round pile. Guide with four rollers.

14" Interior Pile Guide  
**part# DH26434**

Volume Pack 6 pcs

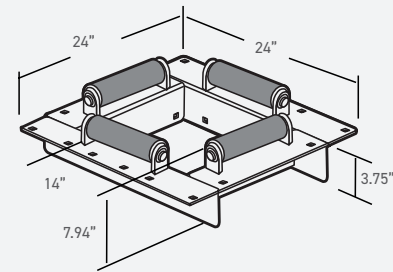
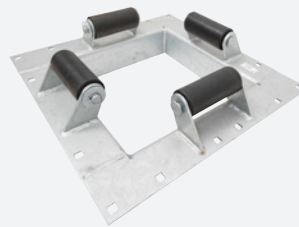
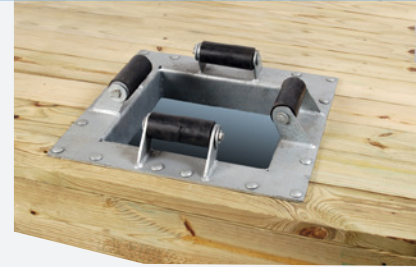

Enhance the performance of your dock  
with Great Lakes Marine Products.

**PILING CAPS**

Keep birds from roosting in your pilings. Mildew inhibitors and UV stabilized. Available in white or black.

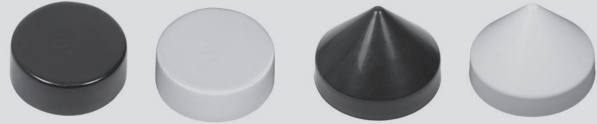

**FLAT PILING CAP**

- Black 6.5" Flat
- White 7" Flat
- Black 7" Flat
- White 7.5" Flat
- Black 7.5" Flat
- White 8" Flat
- Black 8" Flat
- White 9" Flat
- Black 9" Flat
- White 10" Flat
- Black 10" Flat
- White 10.5" Flat
- Black 10.5" Flat
- White 11" Flat
- Black 11" Flat
- White 12" Flat
- Black 12" Flat

- part# FPC65B
- part# FPC7W
- part# FPC7B
- part# FPC75W
- part# FPC75B
- part# FPC8W
- part# FPC8B
- part# FPC9W
- part# FPC9B
- part# FPC10W
- part# FPC10B
- part# FPC105W
- part# FPC105B
- part# FPC11W
- part# FPC11B
- part# FPC12W
- part# FPC12B

**CONE PILING CAP**

- White 7.0" Cone
- Black 7.0" Cone
- White 7.5" Cone
- Black 7.5" Cone
- White 8.0" Cone
- Black 8.0" Cone
- White 8.5" Cone
- Black 8.5" Cone
- White 9.0" Cone
- Black 9.0" Cone
- White 9.5" Cone
- Black 9.5" Cone
- White 10.0" Cone
- Black 10.0" Cone
- White 10.5" Cone
- Black 10.5" Cone
- White 11.0" Cone

- part# CPC7W
- part# CPC7B
- part# CPC75W
- part# CPC75B
- part# CPC8W
- part# CPC8B
- part# CPC85W
- part# CPC85B
- part# CPC9W
- part# CPC9B
- part# CPC95W
- part# CPC95B
- part# CPC10W
- part# CPC10B
- part# CPC105W
- part# CPC105B
- part# CPC11W

- Black 11.0" Cone
- White 11.5" Cone
- Black 11.5" Cone
- White 12.0" Cone
- Black 12.0" Cone
- White 12.5" Cone
- Black 12.5" Cone

- part# CPC11B
- part# CPC115W
- part# CPC115B
- part# CPC12W
- part# CPC12B
- part# CPC125W
- part# CPC125B

**12" PILING HOOP WITH ROLLER AND REMOVABLE END**

Make vertical movement easier in areas with wind, current or tides.

For pilings up to 12" in diameter.

12" Piling Hoop and Roller Assembly  
part# DH26415 Volume Pack 6 pcs

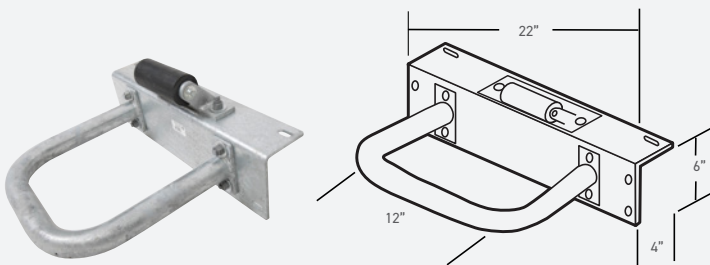

**13" PILING HOOP WITH ROLLER AND REMOVABLE END**

13"x13" Pile hoop with roller and removable end for up to 12" pile.

part# DH26423

Volume Pack 6 pcs

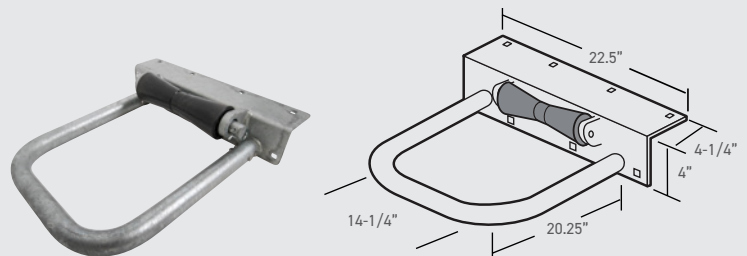



# CAMPER STABILIZERS

## CAMPER STABILIZERS

Lightweight, but heavy-duty stabilizers remove the side-to-side and front-to-back frame movement. No more annoying sway! Stabilize frame heights from 19-26 inches high. Any camper with an exposed frame works well with our camper stabilizers.

Stabilizers  
part# TSTABLE

Complete with:

- Two stabilizing legs
- Two adjustable pins
- Chain
- Binder





*Eliminate annoying camper rocking and swaying with camper stabilizers.*





# OTTER ATV TRAILERS

*Haul up to 15 Cubic Feet and 1500 Pounds!  
10 Year Warranty on Trailer Bed and  
1 Year Warranty on Trailer Components.*

## XPRESS 15 TRAILER

- High Clearance Frame with 3/4D Solid Steel Axle
- Steel Wheels w/ Integrated Greaseable Roller Bearings
  - Industry Strongest Roto-Molded Trailer Body
    - Molded-In Power-Rail Frame
- Reinforced Outer Lip For Remarkable Wall Strength
- Tilt-N-Swivel Side & Rear Dumping w/ Tipper Latch
  - Standard Pin Style Hitch Attachment

### part# DFA201234

Dimensions: 65L x 36W x 14D  
Load Capacity: 1500 Pounds  
Cubic Ft. of Space: 15 Ft.  
Tires: 18 x 7 x 8 Floatation Turf Tires



## XPRESS 20 TRAILER

- High Clearance Frame with 3/4D Solid Steel Axle
- Steel Wheels w/ Integrated Greaseable Roller Bearings
- Standard Pin Style Hitch Attachment
- Optional 2D Ball Coupler Attachment
- Tows Smoothly Behind any ATV / UTV
- Molded-In Power-Rail Frame
- Reinforced Outer Lip For Remarkable Wall Strength
- Tilt-N-Swivel Side & Rear Dumping w/ Tipper Latch

### part# DFA201239

Dimensions: 65L x 46W x 14D  
Load Capacity: 1500 Pounds  
Cubic Ft. of Space: 20 Ft.  
Tires: 18 x 8.5 x 8 Floatation Turf Tires



## SUPER XPRESS 20 TRAILER

### part# DFA201244

Dimensions: 65L x 46W x 14D  
Load Capacity: 1500 Pounds  
Cubic Ft. of Space: 20 Ft.  
Tires: 18 x 9.5 x 8 Floatation Turf Tires

4-bolt hub assembly with greaseable tapered roller bearings.



## TRAVEL COVER

Protect your gear and your load with a Rhino Xpress 20 Trailer Cover. The heavyweight fabric is extremely durable and water-resistant, with a sewn-in shock cord into the hem to seal out the elements. Designed to fit Xpress 20 Off-Road Trailer.

Xpress 15 Travel Cover part# DFA200847





*Make hauling a breeze with large capacity trailers.*

## ATV BOXES

**Standard Lid Model** offers ultra capacity, durability and utility. The standard Lid provides full range of headlight and handlebar clearance. Perfect for ATVs used around the house or cabin, at the farm, or as gear storage while ice fishing or hunting.

Front ATV Box with Standard Lid  
part# DFA200544



**Rear ATV Box** offers ultra capacity, durability and utility for your ATV. Our Rear ATV Box provides a deluxe, wrap-around style fit on the rear of your ATV, complete with a high impact handle, and stainless steel lock. This product offers 10.5 Cubic Feet of Space inside, and allows for storage of extra gear when used around the house or cabin, at the farm or while enjoying the great outdoors.

Rear ATV Box  
part# DFA200543



## BUCKET HOLDER

Constructed of 100% thick, and rugged Roto-Molded Polyethylene. Simply attach this Accessory to your Rhino Rear ATV Box for the simplest way to carry 5 gallon buckets with you during transport. With no tools necessary for installation, you simply need to slide this tank onto the built-in accessory attachment points.

Bucket Holder      part# DFA200829



## AUGER SHIELD

Revolutionary Auger Shield is a full-length ice auger boot that completely encases the auger blade. Constructed of 100% thick and rugged Roto-Molded polyethylene plastic, it protects your expensive gear from being damaged by the sharp, metal edge of your auger blade while protecting the blade itself. A built-in carrying handle makes for easy transport and allows you to conveniently store your shield by hanging it on the wall. Designed for standard length augers. Our Auger Shield fits a 10" auger drill.

Auger Shield      part# DFA200553





# HYDRAULIC BOATLIFT PARTS

## Hydraulic Replacement Parts for Basta

2-year Warranty

### 12V DC MOTOR - MONARCH

Replacement Pump Motor  
part# NAHY50020500811109



### 12 V HYDRAULIC SOLENOID KIT - MONARCH

Replacement Solenoid for Hydraulic Power Unit  
part# NAHYSM12



### HYDRAULIC BOATLIFT OIL

Readily biodegradable oil certified for use around water. If you're looking for oil and it doesn't say "readily biodegradable" or "water use" it is not the correct choice for the environment.

One Gallon  
part# H2OIL

Volume Pack 10 pcs



### HYDRAULIC PUMP CARTRIDGE

Cartridge  
part# NAHY50020160045504



### SOLENOID STRAP - MONARCH

Solenoid Strap  
part# NAHY500207813155



### TUBE, SUCTION - MONARCH

90-degree Suction Tube  
part# NAHY500208301209



### REPLACEMENT WIRE HARNESS FOR BASTA

Replacement Wire Harness  
part# RBRAINBH

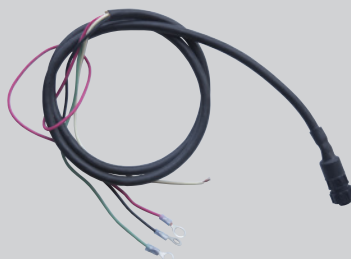

### HOSE KIT FOR BASTA

Stainless Steel Hose Kit for Basta 2,000-8,000 hydraulic lift  
part# RHOSEKB

*Couplers not included.*



*Basta is in no way associated with the products of Great Lakes Marine.*

## Hydraulic Replacement Parts for Basta

2-year Warranty

### KEY FOB

Extra key fob for the Great Lakes replacement brain box.

Key Fob  
part# **LWHDDK**



### REPLACEMENT SUCTION SCREEN FILTER

Filter  
part# **NAHY500203201134**



### REPLACEMENT PUMP BOX FOR BASTA

Complete Box with Pump, Motor, Reservoir, Brain Box and Two Remote Key Fobs  
part# **RPUMPBC**

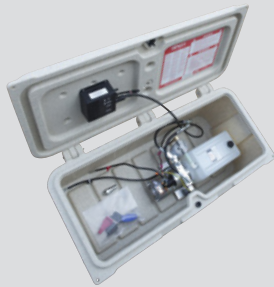

### REPLACEMENT PUMP/MOTOR FOR BASTA

12V Pump/Motor and Reservoir  
part# **RPUMPB**



### REPLACEMENT BRAIN BOX WITH HARNESS BOX FOR BASTA

Replacement Brain with Manual Switch  
part# **RBRAINB**

*Includes two remotes and wire harness.*



### REPLACEMENT CYLINDER FOR BASTA

Aluminum cylinder with stainless steel shaft.

Cylinder  
part# **RCYLINDERB**



*Basta is in no way associated with the products of Great Lakes Marine.*



# HYDRAULIC BOATLIFT PARTS

## Hydraulic Replacement Parts for Shore Mate

2-year Warranty

### HYDRAULIC BOATLIFT OIL

Readily biodegradable oil certified for use around water. If you're looking for oil and it doesn't say "readily biodegradable" or "water use" it is not the correct choice for the environment.

One Gallon  
**part# H2OIL**

Volume Pack 10 pcs



### SHORE MATE HOSE KIT (2-CYLINDER)

Stainless steel hose kit for Shore Mate 4,000-6,000 Hydraulic Lift

Hose Kit  
**part# RHOSEKSM**

*Couplers not included.*



### REPLACEMENT HYDRAULIC CYLINDERS FOR SHORE MATE

New Style Replacement Cylinder with stainless steel shaft  
28-1/4" Retracted, 48-1/4" Extended  
**part# RCYLINDERSMN**

Old Style Replacement Cylinder  
33-3/4" Retracted, 48" Extended  
**part# RCYLINDERSMO**

*New and old differ in the lift design. They are not interchangeable with each other.*



*Shore Mate is in no way associated with the products of Great Lakes Marine.*

## Hydraulic Replacement Parts for RGC

2-year Warranty

### HYDRAULIC BOATLIFT OIL

Readily biodegradable oil certified for use around water. If you're looking for oil and it doesn't say "readily biodegradable" or "water use" it is not the correct choice for the environment.

One Gallon  
part# H2OIL

Volume Pack 10 pcs



### SS HOSE KIT FOR RGC

Stainless steel hose kit for RGC 4,000-6,000  
Hydraulic Lift

Hose Kit  
part# RHOSEKRG

*Couplers not included.*



### REPLACEMENT CYLINDER FOR RGC

Aluminum cylinder with  
stainless steel shaft.

part# RYLINDERRGC



**Don't see what  
you're looking for?  
Talk to our  
friendly staff!**

*RGC is in no way associated with the products of Great Lakes Marine.*



# HYDRAULIC BOATLIFT PARTS

Sunlift is a freestanding lift that sits on the bottom.  
Floatlift is a floating lift.

## REPLACEMENT STAINLESS STEEL HOSE FOR FLOATLIFT 240"

One Hose  
part# RHOSEKSSFL6-240



## REPLACEMENT HOSE FOR FLOATLIFT 78"

One Hose  
part# RHOSEKSSFL13-78



## HOSE KIT – FL13 (FLOATLIFT)

Stainless steel replacement hose kit for 10,000-13,000 Hydraulic Floatlift.

Kit  
part#RHOSEKSSFL13

*Couplers not included.*

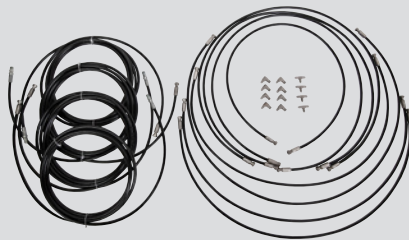

## REPLACEMENT STAINLESS STEEL HOSE FOR FLOATLIFT 252"

One Hose  
part# RHOSEKSSFL13-252



## HOSE KIT – FL6 (FLOATLIFT)

Stainless steel replacement hose kit for 6,000 Hydraulic Floatlift.

Kit  
part# RHOSEKSSFL6

*Couplers not included.*



## HOSE KIT – PWC-SL (SUNLIFT)

Stainless steel replacement hose kit for 2,000-3,000 Hydraulic Sunlift.

Kit  
part# RHOSEKSSP

*Couplers not included.*



## HOSE KIT – SL (SUNLIFT)

Stainless steel replacement hose kit for 4,500-6,500 Hydraulic Sunlift.

Kit  
part# RHOSEKSS

*Couplers not included.*



## HOSE KIT – SL (LARGE)

Stainless steel replacement hose kit for 8,000-12,000 Hydraulic Sunlift.

Kit  
part# RHOSEKSSL

*Couplers not included.*

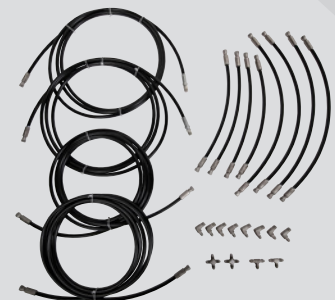

*Sunstream is in no way associated with the products of Great Lakes Marine.*

## Hydraulic Replacement Parts for Sunstream

2-year Warranty

### SCREW COUPLER SET FOR SUNSTREAM HYDRAULIC PUMP

Coupler Set (one)  
part# RPUMPSSCOUPLER



### REPLACEMENT CYLINDER FOR SUNSTREAM

Stainless steel shaft and exterior coating.

Cylinder  
part# RCYLINDER



### REPLACEMENT STAINLESS STEEL HOSE FOR FLOATLIFT 258"

One Hose  
part# RHOSEKSSFL6-258



### HYDRAULIC BOATLIFT OIL

Readily biodegradable oil certified for use around water. If you're looking for oil and it doesn't say "readily biodegradable" or "water use" it is not the correct choice for the environment.

One Gallon      Volume Pack 10 pcs  
part# H2OIL



### REPLACEMENT HOSE FOR SUNLIFT 169"

One Hose  
part# RHOSEKSSSL6-169



### REPLACEMENT HOSE FOR FLOATLIFT 60"

One Hose  
part# RHOSEKSSFL13-60

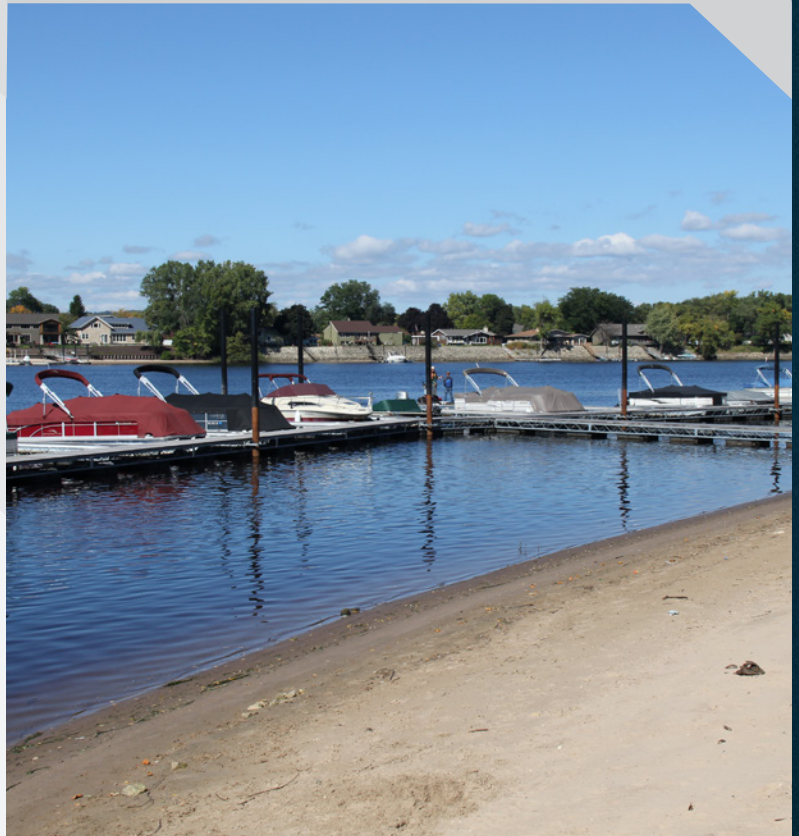

Sunstream is in no way associated with the products of Great Lakes Marine.



# HYDRAULIC BOATLIFT PARTS

Sunlift is a freestanding lift that sits on the bottom.  
Floatlift is a floating lift.

## REPLACEMENT BRAIN BOX FOR SUNSTREAM

Brain Box  
part# RBRAINSS

Includes two remotes.



## KEY FOB

Extra key fob for the Great Lakes replacement brain box.

Key Fob  
part# LWHDDK



## REPLACEMENT WIRE HARNESS FOR SUNSTREAM SUNLIFT

Harness part# RBRAINSSH



## REPLACEMENT WIRE HARNESS FOR SUNSTREAM FLOATLIFT

6,000 FL Harness part# RBRAINSSHFL6  
13,000 FL Harness part# RBRAINSSHFL13



## COMPLETE REPLACEMENT PUMP BOX FOR SUNSTREAM (FLOATLIFT & SUNLIFT)

Includes two remotes.

2,000 to 12,000 Sunlift Pump Box  
part# RPUMPSSC



6,000 Floatlift Pump Box 12V  
part# RPUMPSSCFL

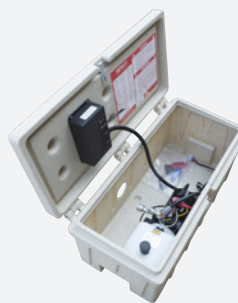

13,000 Floatlift Pump Box 24V  
part# RPUMPSSCFL13

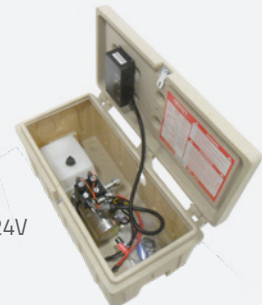

## 12V REPLACEMENT PUMP/ MOTOR FOR SUNSTREAM (SUNLIFT)

Pump/Motor and Reservoir  
part# RPUMPSS



## REPLACEMENT PUMP/MOTOR FOR SUNSTREAM (FLOATLIFT)

For 6,000 Floatlift 12V  
Pump/Motor and Reservoir  
part# RPUMPSSFL

For 10,000-13,000 Floatlift 12V  
Pump/Motor and Reservoir  
part# RPUMPSSFL13



Sunstream is in no way associated with the products of Great Lakes Marine.

## Hydraulic Replacement Parts for Sunstream

2-year Warranty

### REPLACEMENT PUMP FOR SUNSTREAM

Pump  
part# RPUMPSS12P



### REPLACEMENT MOTOR FOR SUNSTREAM

Replacement Pump Motor 12V  
part# RPUMPSS12M



Replacement Pump Motor 24V  
part# RPUMPSS24M

### SUNSTREAM FL PILOT-OPERATED CK VALVE

Ck Valve  
part# RPUMPSSFL12CV



### 12V STARTER SOLENOID FOR SUNSTREAM

Replacement Solenoid  
for Hydraulic Power Unit  
part# RPUMPSS12S

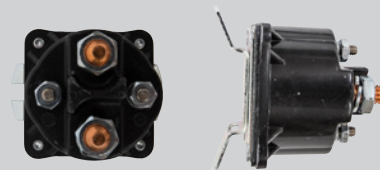

### 2-WAY CARTRIDGE VALVE FOR SUNSTREAM

Valve  
part# RPUMPSS12C2



### DC COIL FOR SUNSTREAM

Coil  
part# RPUMPSS12C



### 4-WAY CARTRIDGE VALVE FOR SUNSTREAM

Cartridge  
part# RPUMPSS12C4



### REPLACEMENT SUCTION SCREEN FILTER

Filter  
part# NAHY1611-AA



*Sunstream is in no way associated with the products of Great Lakes Marine.*



# CANOPY REPAIR & ACCESSORIES

## CANOPY STORAGE NET

Storage net creates storage under your canopy. Net protects gear from sun, rain, wind, and theft. Installs with quick release clips in minutes. No tools required. Makes boating much more enjoyable. Turn your canopy into a boathouse today.

Size	Width	Part #
Small	96" - 107"	LDCS1096
Medium	108" - 120"	LDCS1108
Large	121" - 138"	LDCS1138

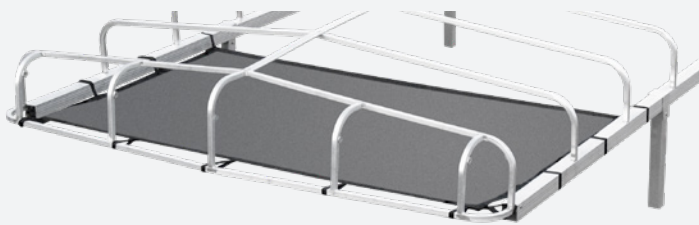

## CANOPY REPAIR KITS

Did you have an accident and puncture your canvas? No problem. This canvas repair kit is easy to use for permanent repairs of small holes and cuts in your canvas. This patch kit comes with a 4 oz. can of adhesive with brush and one 1/4 square yard of fabric in your color choice.

Vinyl  
Defender  
SeaMark

part# REPAIR-(color)  
part# REPAIRD-(color)  
part# REPAIRS-(color)



## BIRD DETERRENT

Keep birds away and your canopy clean. Bracket attaches to a lift up-right and then over the canopy frame. Allows removal of your canopy cover without having to remove the bird deterrent.

part# DBIRDC

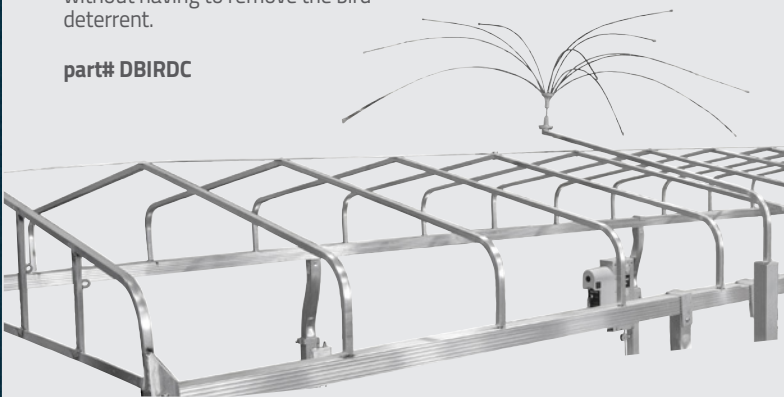

## CANOPY MESH SKIRT

42" mesh skirt that attaches to the canopy frame work.

Call for more information.



## CANOPY LED LIGHTING

Wireless light kit turns your boat and boat lift canopy into an extended evening entertainment area, adding ample light to continue the festivities. Just a quick click on the remote (included) will turn the lights on or off.

part# LWHDDCLR







### VINYL CANOPY COLORS

<b>Black (BLK)</b> BLACK TRIM	<b>Gray (GRY)</b> BLACK TRIM
<b>Beige (BEI)</b> BROWN TRIM	<b>Green (GRN)</b> BLACK TRIM
<b>Blue (BLU)</b> WHITE TRIM	<b>Yellow (YEL)</b> WHITE TRIM
<b>White (WHI)</b> WHITE TRIM	

Three-letter color code abbreviations for part numbers noted in parenthesis.

### DEFENDER FABRIC CANOPY COLORS

<b>Burgundy (BUR)</b> WHITE TRIM	<b>Midnight (MID)</b> BLACK TRIM
<b>Dubonnet Tweed (DUB)</b> BLACK TRIM	<b>Cadet (CAD)</b> BLACK TRIM
<b>Pacific (PAC)</b> WHITE TRIM	<b>Linen Tweed (LIN)</b> BLACK TRIM
<b>Charcoal Tweed (CHA)</b> BLACK TRIM	<b>Forest (FOR)</b> BLACK TRIM
<b>Toast (TST)</b> BROWN TRIM	<b>Navy (NAV)</b> WHITE TRIM
<b>Hemlock Tweed (HEM)</b> BLACK TRIM	





# REPLACEMENT CANOPIES

Protect your boat with a canopy cover from Great Lakes Marine Products.

## ALLEN DOCK REPLACEMENT CANOPY

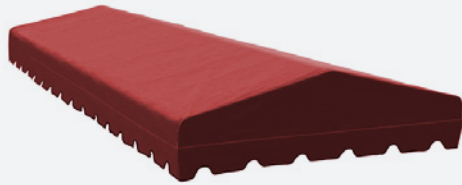

	Defender	Vinyl	Size/Color
part#	CALD-	CALV-	17x90???

## MEASURING INSTRUCTIONS

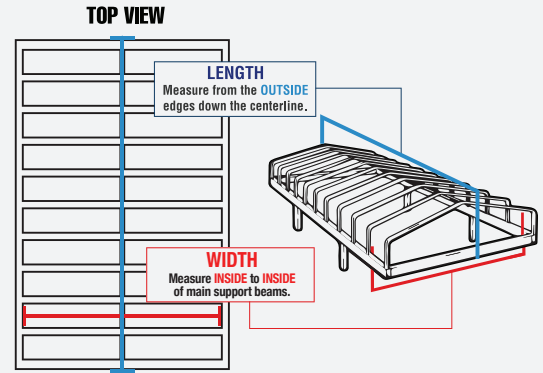

## CRAFTLANDER REPLACEMENT CANOPY



	Defender	Vinyl	Size/Color
part#	CCLD-	CCLV-	22x108???

## MEASURING INSTRUCTIONS

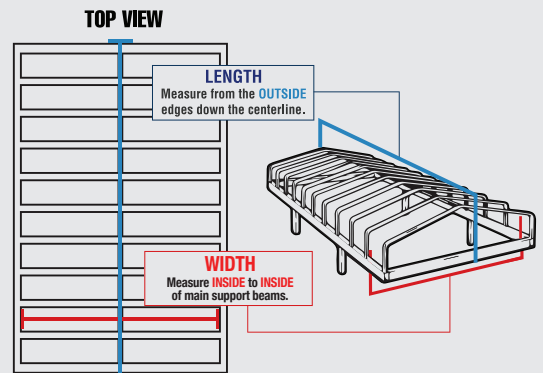

## MIDLANDER REPLACEMENT CANOPY

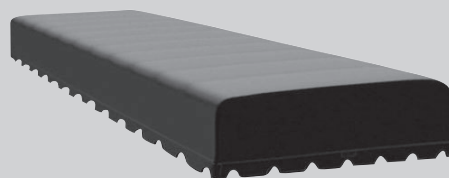

	Defender	Vinyl	Size/Color
part#	CMLD-	CMLV-	23x110???

## MEASURING INSTRUCTIONS

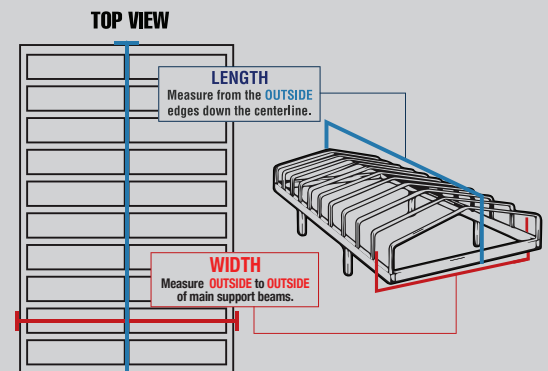

Brands above are in no way associated with the products of Great Lakes Marine.

VINYL CANOPY COLORS

Black BLACK TRIM	Gray BLACK TRIM	Beige BROWN TRIM	Blue WHITE TRIM	Green BLACK TRIM	Yellow WHITE TRIM	White WHITE TRIM
---------------------	--------------------	---------------------	--------------------	---------------------	----------------------	---------------------

View larger swatches and color codes on page 74.

DEFENDER FABRIC CANOPY COLORS

Burgundy WHITE TRIM	Midnight BLACK TRIM	Dubonnet Tweed BLACK TRIM	Cadet BLACK TRIM	Pacific WHITE TRIM	Linen Tweed BLACK TRIM	Charcoal Tweed BLACK TRIM	Forest BLACK TRIM	Toast BROWN TRIM	Navy WHITE TRIM	Hemlock Tweed BLACK TRIM
------------------------	------------------------	---------------------------------	---------------------	-----------------------	------------------------------	---------------------------------	----------------------	---------------------	--------------------	--------------------------------



All canopy orders include toggle cords for installation.

DAKA REPLACEMENT CANOPY

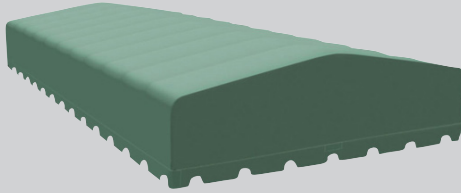

part#	Defender	Vinyl	Size/Color
CDKD-	CDKV-	20x96???	
CDKD-	CDKV-	24x96???	
CDKD-	CDKV-	22x108???	
CDKD-	CDKV-	24x108???	
CDKD-	CDKV-	26x108???	
CDKD-	CDKV-	20x115???	
CDKD-	CDKV-	22x115???	
CDKD-	CDKV-	24x115???	
CDKD-	CDKV-	26x115???	
CDKD-	CDKV-	28x115???	
CDKD-	CDKV-	30x115???	

MEASURING INSTRUCTIONS

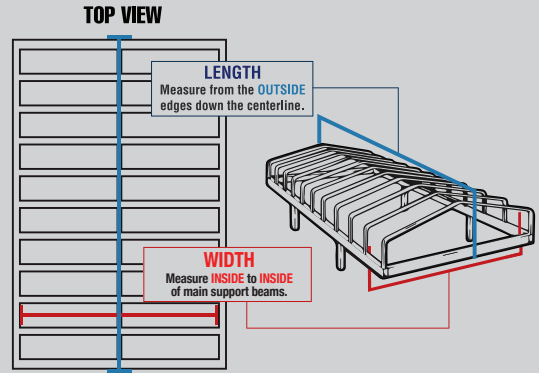

AQUA LIFT REPLACEMENT CANOPY



part#	Defender	Vinyl	Size/Color
CAQD-	CAQV-	22x108???	
CAQD-	CAQV-	24x108???	
CAQD-	CAQV-	28x108???	
CAQD-	CAQV-	23x120???	

MEASURING INSTRUCTIONS

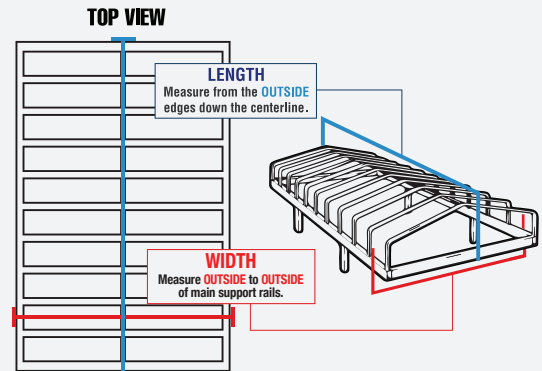

DEMCO REPLACEMENT CANOPY

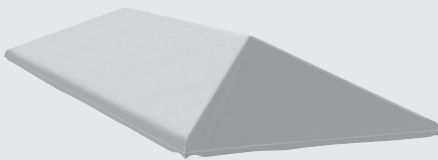

part#	Defender	Vinyl	Size/Color
CDCD-	CDCV-	20x113???	

MEASURING INSTRUCTIONS

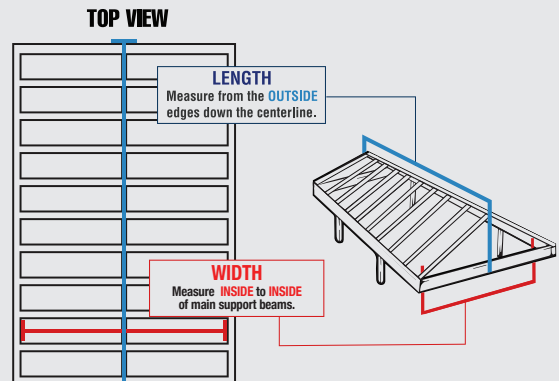

Brands above are in no way associated with the products of Great Lakes Marine.



# REPLACEMENT CANOPIES

Looking for something different?  
Contact us about a custom canopy.

## DOCK RITE OF CANADA REPLACEMENT CANOPY

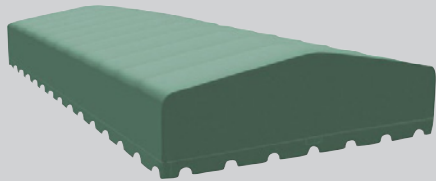

part#	Defender	Vinyl	Size/Color
	CDRCD-	CDRCV-	26x114???

## MEASURING INSTRUCTIONS

### TOP VIEW

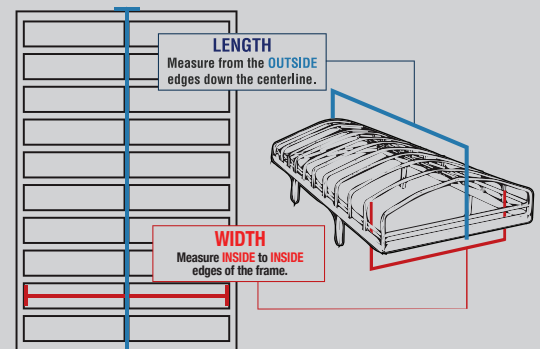

## DOCK RITE REPLACEMENT CANOPY



part#	Defender	Vinyl	Size/Color
	CDRD-	CDRV-	12x75???
	CDRD-	CDRV-	19x84???
	CDRD-	CDRV-	21x96???
	CDRD-	CDRV-	23x114???
	CDRD-	CDRV-	26x114???
	CDRD-	CDRV-	23x120???
	CDRD-	CDRV-	26x120???

## MEASURING INSTRUCTIONS

### TOP VIEW

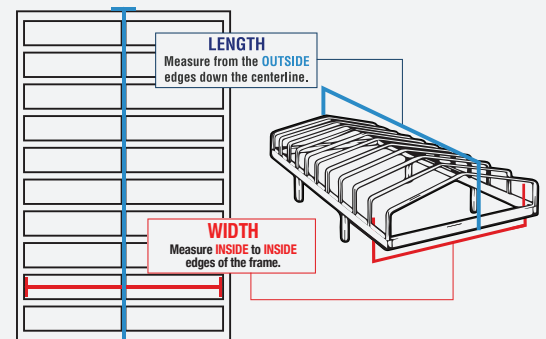

## DOCKSIDE REPLACEMENT CANOPY



part#	Defender	Vinyl	Size/Color
	CDSCV-	CDSCV-	22x112???
	CDSCV-	CDSCV-	25x112???
	CDSBV-	CDSBV-	25x124???
	CDSAV-	CDSAV-	25x128???

## MEASURING INSTRUCTIONS

### TOP VIEW

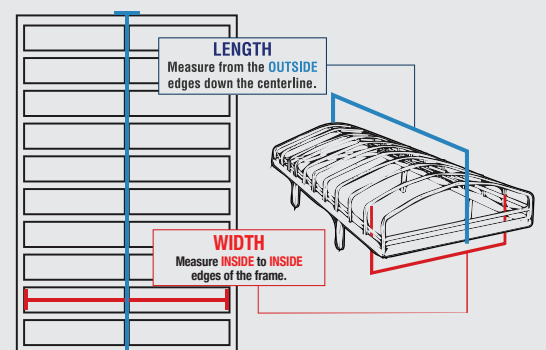

Brands above are in no way associated with the products of Great Lakes Marine.

VINYL CANOPY COLORS

Black BLACK TRIM	Gray BLACK TRIM	Beige BROWN TRIM	Blue WHITE TRIM	Green BLACK TRIM	Yellow WHITE TRIM	White WHITE TRIM
---------------------	--------------------	---------------------	--------------------	---------------------	----------------------	---------------------

View larger swatches and color codes on page 74.

DEFENDER FABRIC CANOPY COLORS

Burgundy WHITE TRIM	Midnight BLACK TRIM	Dubonnet Tweed BLACK TRIM	Cadet BLACK TRIM	Pacific WHITE TRIM	Linen Tweed BLACK TRIM	Charcoal Tweed BLACK TRIM	Forest BLACK TRIM	Toast BROWN TRIM	Navy WHITE TRIM	Hemlock Tweed BLACK TRIM
------------------------	------------------------	---------------------------------	---------------------	-----------------------	------------------------------	---------------------------------	----------------------	---------------------	--------------------	--------------------------------



All canopy orders include toggle cords for installation.

FEIGNER REPLACEMENT CANOPY



part#	Defender	Vinyl	Size/Color
CFED-	CFED-	CFEV-	24x114???
CFED-	CFED-	CFEV-	30x120???

MEASURING INSTRUCTIONS

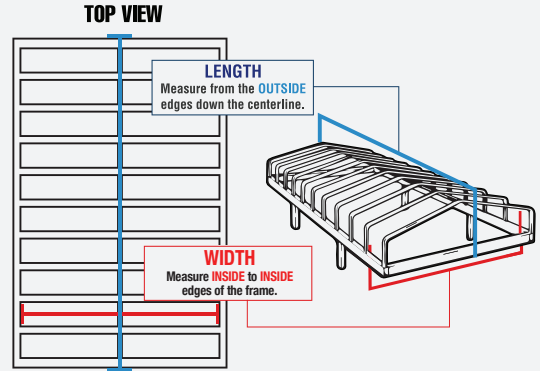

FLOE REPLACEMENT CANOPY



part#	Defender	Vinyl	Size/Color
CFLD-	CFLD-	CFLV-	20x96???
CFLD-	CFLD-	CFLV-	20x108???
CFLD-	CFLD-	CFLV-	22x108???
CFLD-	CFLD-	CFLV-	24x108???
CFLD-	CFLD-	CFLV-	12x116???
CFLD-	CFLD-	CFLV-	22x116???
CFLD-	CFLD-	CFLV-	24x116???
CFLD-	CFLD-	CFLV-	26x116???
CFLD-	CFLD-	CFLV-	28x116???
CFLD-	CFLD-	CFLV-	30x116???
CFLD-	CFLD-	CFLV-	26x119???
CFLD-	CFLD-	CFLV-	28x126???
CFLD-	CFLD-	CFLV-	30x126???
CFLD-	CFLD-	CFLV-	32x126???
CFLD-	CFLD-	CFLV-	34x126???

MEASURING INSTRUCTIONS

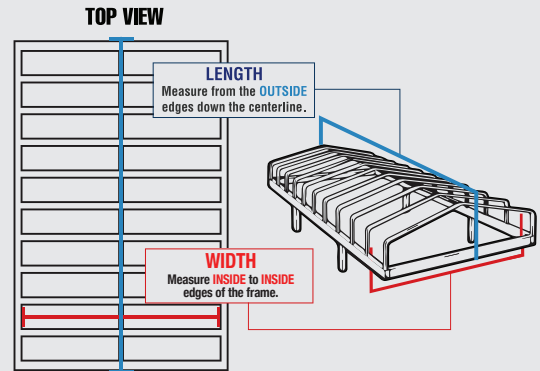

GREAT LAKES REPLACEMENT CANOPY



part#	Defender	Vinyl	Size/Color
CGLD-	CGLD-	CGLV-	20x116???
CGLD-	CGLD-	CGLV-	23x116???
CGLD-	CGLD-	CGLV-	23x120???
CGLD-	CGLD-	CGLV-	20x126???
CGLD-	CGLD-	CGLV-	23x126???
CGLD-	CGLD-	CGLV-	25x126???
CGLD-	CGLD-	CGLV-	27x126???

MEASURING INSTRUCTIONS

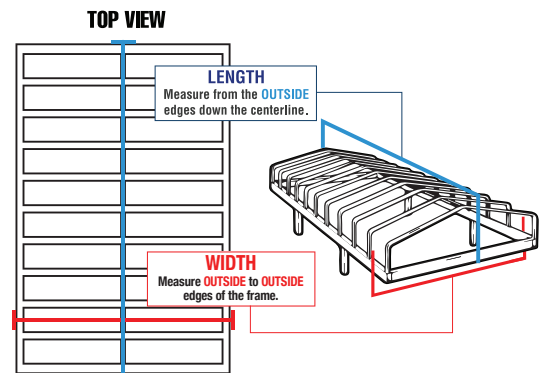

Brands above are in no way associated with the products of Great Lakes Marine.



# REPLACEMENT CANOPIES

## HEWITT REPLACEMENT CANOPY



part#	Defender	Vinyl	Size/Color
part#	LCXD-	LCX-	10x60???
part#	LCXD-	LCX-	10x71???
part#	LCXD-	LCX-	12x71???
part#	LCXD-	LCX-	10x87???
part#	LCXD-	LCX-	12x87???
part#	LCXD-	LCX-	18x87???
part#	LCXD-	LCX-	10x100???
part#	LCXD-	LCX-	12x100???
part#	LCXD-	LCX-	18x100???
part#	LCXD-	LCX-	20x100???
part#	LCXD-	LCX-	22x100???
part#	LCXD-	LCX-	24x100???
part#	LCXD-	LCX-	30x100???
part#	LCXD-	LCX-	10x110???
part#	LCXD-	LCX-	12x110???
part#	LCXD-	LCX-	18x110???
part#	LCXD-	LCX-	20x110???
part#	LCXD-	LCX-	22x110???
part#	LCXD-	LCX-	24x110???
part#	LCXD-	LCX-	26x110???
part#	LCXD-	LCX-	28x110???
part#	LCXD-	LCX-	30x110???
part#	LCXD-	LCX-	12x120???
part#	LCXD-	LCX-	20x120???
part#	LCXD-	LCX-	23x120???
part#	LCXD-	LCX-	25x120???
part#	LCXD-	LCX-	27x120???
part#	LCXD-	LCX-	29x120???
part#	LCXD-	LCX-	31x120???
part#	LCXD-	LCX-	35x120???
part#	LCXD-	LCX-	37x120???

## MEASURING INSTRUCTIONS

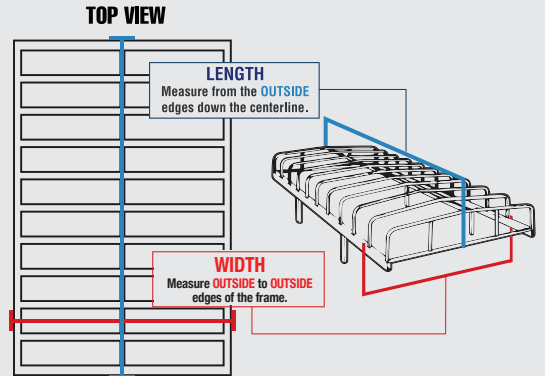

part#	Defender	Vinyl	Size/Color
part#	LCXD-	LCX-	12x138???
part#	LCXD-	LCX-	20x138???
part#	LCXD-	LCX-	23x138???
part#	LCXD-	LCX-	25x138???
part#	LCXD-	LCX-	27x138???
part#	LCXD-	LCX-	29x138???
part#	LCXD-	LCX-	31x138???
part#	LCXD-	LCX-	33x138???
part#	LCXD-	LCX-	35x138???
part#	LCXD-	LCX-	37x138???
part#	LCXD-	LCX-	42x138???

## HARBOR MASTER REPLACEMENT CANOPY



part#	Defender	Vinyl	Size/Color
part#	CHMD-	CHMV-	18x100???
part#	CHMD-	CHMV-	21x100???
part#	CHMD-	CHMV-	19x108???
part#	CHMD-	CHMV-	21x108???
part#	CHMD-	CHMV-	24x108???
part#	CHMD-	CHMV-	24x108F???
part#	CHMD-	CHMV-	21x114???
part#	CHMD-	CHMV-	24x114???
part#	CHMD-	CHMV-	24x114F???
part#	CHMD-	CHMV-	27x114???
part#	CHMD-	CHMV-	24x120???
part#	CHMD-	CHMV-	24x120F???
part#	CHMD-	CHMV-	27x120???
part#	CHMD-	CHMV-	30x120???

## MEASURING INSTRUCTIONS

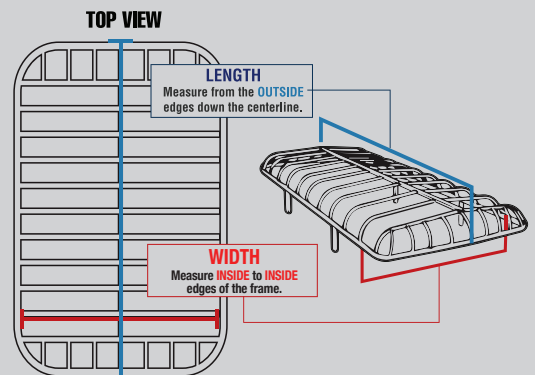

Harbor Master is in no way associated with the products of Great Lakes Marine.

VINYL CANOPY COLORS

Black BLACK TRIM	Gray BLACK TRIM	Beige BROWN TRIM	Blue WHITE TRIM	Green BLACK TRIM	Yellow WHITE TRIM	White WHITE TRIM
---------------------	--------------------	---------------------	--------------------	---------------------	----------------------	---------------------

View larger swatches and color codes on page 74.

DEFENDER FABRIC CANOPY COLORS

Burgundy WHITE TRIM	Midnight BLACK TRIM	Dubonnet Tweed BLACK TRIM	Cadet BLACK TRIM	Pacific WHITE TRIM	Linen Tweed BLACK TRIM	Charcoal Tweed BLACK TRIM	Forest BLACK TRIM	Toast BROWN TRIM	Navy WHITE TRIM	Hemlock Tweed BLACK TRIM
------------------------	------------------------	---------------------------------	---------------------	-----------------------	------------------------------	---------------------------------	----------------------	---------------------	--------------------	--------------------------------



All canopy orders include toggle cords for installation.

LAKESHORE REPLACEMENT CANOPY

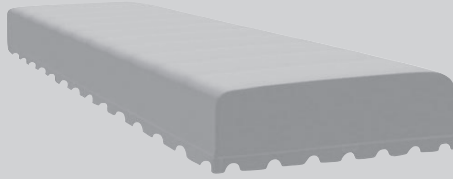

part#	Defender	Vinyl	Size/Color
	CLSD-	CLSV-	14x64???

MEASURING INSTRUCTIONS

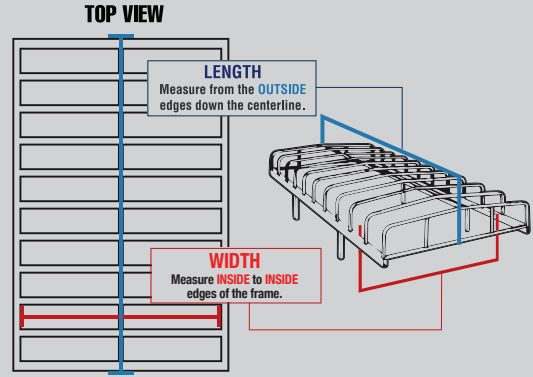

NYMAN REPLACEMENT CANOPY



part#	Defender	Vinyl	Size/Color
	CNYD-	CNYV-	22x108???
	CNYD-	CNYV-	24x108???

MEASURING INSTRUCTIONS

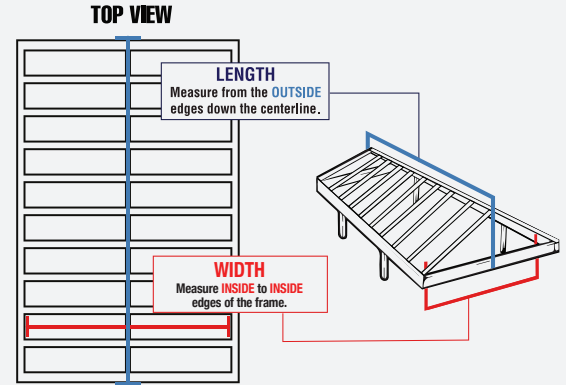

NEWMAN REPLACEMENT CANOPY



part#	Defender	Vinyl	Size/Color
	CNMD-	CNMV-	20x96???
	CNMD-	CNMV-	20x108???
	CNMD-	CNMV-	24x108???
	CNMD-	CNMV-	24x120???
	CNMD-	CNMV-	28x120???

MEASURING INSTRUCTIONS

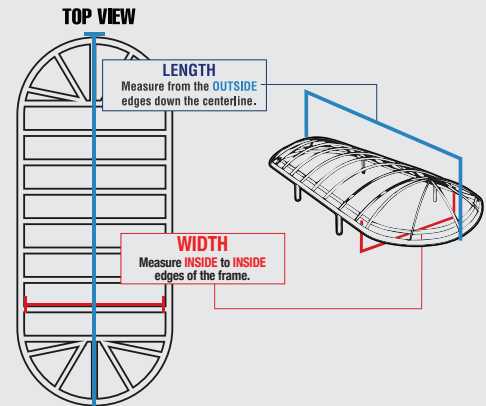

Brands above are in no way associated with the products of Great Lakes Marine.



# REPLACEMENT CANOPIES

Quality, huge selection  
and excellent customer service.

## PIER PLEASURE REPLACEMENT CANOPY

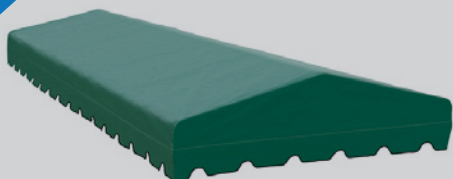

part#	Defender	Vinyl	Size/Color
part#	CPPD-	CPPV-	10x58???
part#	CPPD-	CPPV-	12x58???
part#	CPPD-	CPPV-	12x64???
part#	CPPD-	CPPV-	14x64???
part#	CPPD-	CPPV-	12x84???
part#	CPPD-	CPPV-	14x84???
part#	CPPD-	CPPV-	16x84???
part#	CPPD-	CPPV-	18x84???
part#	CPPD-	CPPV-	20x84???
part#	CPPD-	CPPV-	14x96???
part#	CPPD-	CPPV-	16x96???
part#	CPPD-	CPPV-	18x96???
part#	CPPD-	CPPV-	20x96???
part#	CPPD-	CPPV-	22x96???
part#	CPPD-	CPPV-	18x108???
part#	CPPD-	CPPV-	20x108???
part#	CPPD-	CPPV-	22x108???
part#	CPPD-	CPPV-	24x108???
part#	CPPD-	CPPV-	26x108???
part#	CPPD-	CPPV-	12x114???
part#	CPPD-	CPPV-	14x114???
part#	CPPD-	CPPV-	22x114???
part#	CPPD-	CPPV-	24x114???
part#	CPPD-	CPPV-	26x114???
part#	CPPD-	CPPV-	28x114???
part#	CPPD-	CPPV-	30x114???
part#	CPPD-	CPPV-	24x120???
part#	CPPD-	CPPV-	26x120???

## MEASURING INSTRUCTIONS

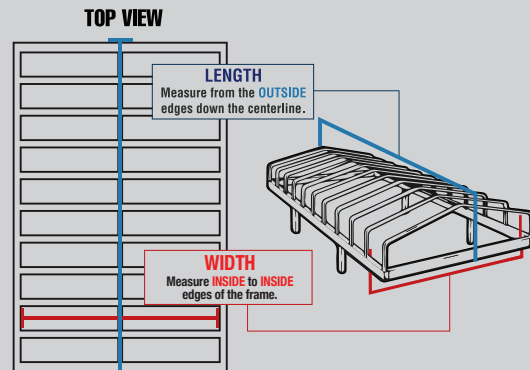

part#	Defender	Vinyl	Size/Color
part#	CPPD-	CPPV-	28x120???
part#	CPPD-	CPPV-	30x120???
part#	CPPD-	CPPV-	32x120???
part#	CPPD-	CPPV-	34x120???
part#	CPPD-	CPPV-	26x132???
part#	CPPD-	CPPV-	28x132???
part#	CPPD-	CPPV-	30x132???
part#	CPPD-	CPPV-	32x132???
part#	CPPD-	CPPV-	34x132???

## PORTA DOCK REPLACEMENT CANOPY



part#	Defender	Vinyl	Size/Color
part#	CPDD-	CPDV-	20x84???
part#	CPDD-	CPDV-	20x96???
part#	CPDD-	CPDV-	22x96???
part#	CPDD-	CPDV-	24x108???
part#	CPDD-	CPDV-	22x114???
part#	CPDD-	CPDV-	24x114???
part#	CPDD-	CPDV-	26x114???
part#	CPDD-	CPDV-	28x114???
part#	CPDD-	CPDV-	30x114???
part#	CPDD-	CPDV-	22x120???
part#	CPDD-	CPDV-	24x120???
part#	CPDD-	CPDV-	26x120???
part#	CPDD-	CPDV-	28x120???
part#	CPDD-	CPDV-	30x120???

## MEASURING INSTRUCTIONS

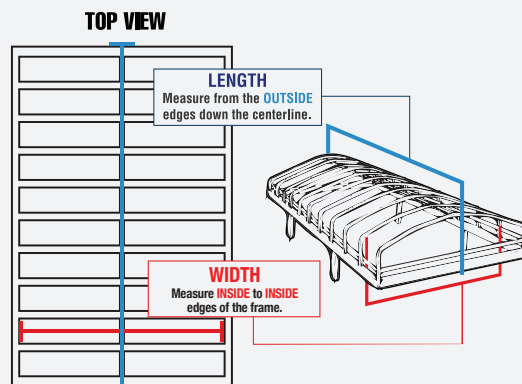

Brands above are in no way associated with the products of Great Lakes Marine.

VINYL CANOPY COLORS

Black BLACK TRIM	Gray BLACK TRIM	Beige BROWN TRIM	Blue WHITE TRIM	Green BLACK TRIM	Yellow WHITE TRIM	White WHITE TRIM
---------------------	--------------------	---------------------	--------------------	---------------------	----------------------	---------------------

View larger swatches and color codes on page 74.

DEFENDER FABRIC CANOPY COLORS

Burgundy WHITE TRIM	Midnight BLACK TRIM	Dubonnet Tweed BLACK TRIM	Cadet BLACK TRIM	Pacific WHITE TRIM	Linen Tweed BLACK TRIM	Charcoal Tweed BLACK TRIM	Forest BLACK TRIM	Toast BROWN TRIM	Navy WHITE TRIM	Hemlock Tweed BLACK TRIM
------------------------	------------------------	------------------------------	---------------------	-----------------------	---------------------------	------------------------------	----------------------	---------------------	--------------------	-----------------------------



All canopy orders include toggle cords for installation.

RGC REPLACEMENT CANOPY



New 28" Tall Frames

part#	Defender	Vinyl	Size/Color
CRGD-	CRGD-	CRGV-	21x100???
CRGD-	CRGD-	CRGV-	21x108???
CRGD-	CRGD-	CRGV-	24x108???
CRGD-	CRGD-	CRGV-	26x108???
CRGD-	CRGD-	CRGV-	24x116???
CRGD-	CRGD-	CRGV-	26x116???
CRGD-	CRGD-	CRGV-	28x116???
CRGD-	CRGD-	CRGV-	30x116???
CRGD-	CRGD-	CRGV-	24x124???
CRGD-	CRGD-	CRGV-	26x124???
CRGD-	CRGD-	CRGV-	28x124???
CRGD-	CRGD-	CRGV-	30x124???
CRGD-	CRGD-	CRGV-	32x124???
CRGD-	CRGD-	CRGV-	34x124???
CRGD-	CRGD-	CRGV-	36x132???
CRGD-	CRGD-	CRGV-	40x132???

Old 26" Tall Frames

part#	Defender	Vinyl	Size/Color
CRG1D-	CRG1D-	CRG1V-	24x124???
CRG1D-	CRG1D-	CRG1V-	26x124???
CRG1D-	CRG1D-	CRG1V-	28x124???
CRG1D-	CRG1D-	CRG1V-	32x124???
CRG1D-	CRG1D-	CRG1V-	34x124???

MEASURING INSTRUCTIONS

TOP VIEW

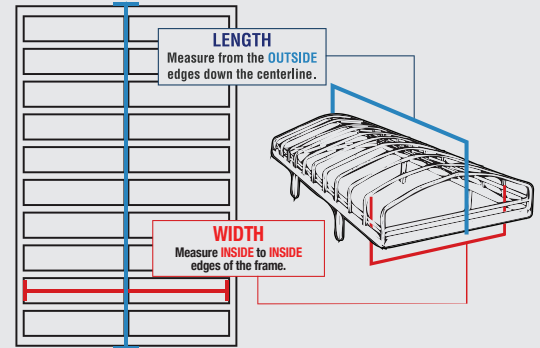

SHOREMATE REPLACEMENT CANOPY

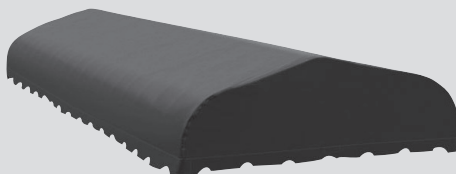

part#	Defender	Vinyl	Size/Color
CSHD-	CSHD-	CSHV-	21x100???
CSHD-	CSHD-	CSHV-	23x108???
CSHD-	CSHD-	CSHV-	23x114???
CSHD-	CSHD-	CSHV-	25x114???
CSHD-	CSHD-	CSHV-	23x120???

MEASURING INSTRUCTIONS

TOP VIEW

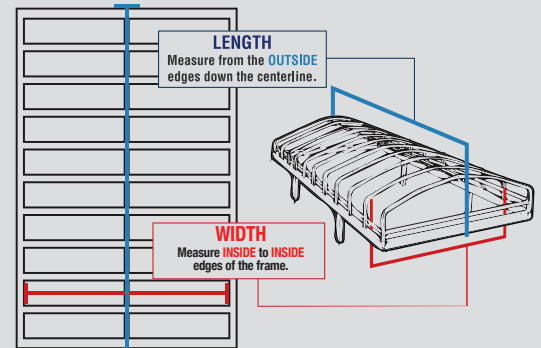

Brands above are in no way associated with the products of Great Lakes Marine.



# REPLACEMENT CANOPIES

Choose from our wide selection of Vinyl or Searmark fabric colors.

## SEALEGS REPLACEMENT CANOPY

## MEASURING INSTRUCTIONS



part#	Defender	Vinyl	Size/Color
	CSLD-	CSLV-	26x120???

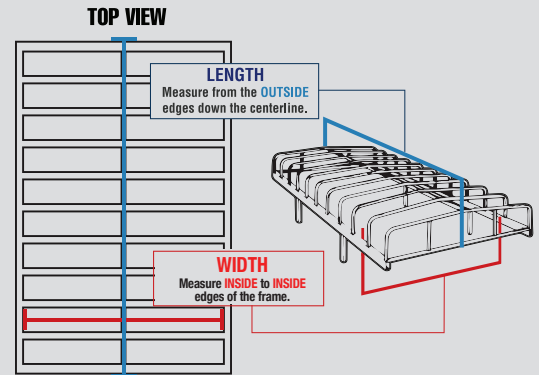

## SHORE MASTER REPLACEMENT CANOPY

## MEASURING INSTRUCTIONS



part#	Defender	Vinyl	Size/Color
part#	CSMD-	CSMV-	13x64???
part#	CSMD-	CSMV-	19x84???
part#	CSMD-	CSMV-	19x96???
part#	CSMD-	CSMV-	21x96???
part#	CSMD-	CSMV-	23x100???
part#	CSMD-	CSMV-	19x108???
part#	CSMD-	CSMV-	21x108???
part#	CSMD-	CSMV-	22x108F???
part#	CSMD-	CSMV-	23x108???
part#	CSMD-	CSMV-	25x108???
part#	CSMD-	CSMV-	27x108???
part#	CSMD-	CSMV-	29x108???
part#	CSMD-	CSMV-	21x120???
part#	CSMD-	CSMV-	23x120???
part#	CSMD-	CSMV-	25x120???
part#	CSMD-	CSMV-	27x120???
part#	CSMD-	CSMV-	29x120???
part#	CSMD-	CSMV-	30x120???
part#	CSMD-	CSMV-	31x120???
part#	CSMD-	CSMV-	33x120???
part#	CSMD-	CSMV-	27x132???
part#	CSMD-	CSMV-	29x132???
part#	CSMD-	CSMV-	31x132???
part#	CSMD-	CSMV-	32x132???
part#	CSMD-	CSMV-	33x132???
part#	CSMD-	CSMV-	35x132???

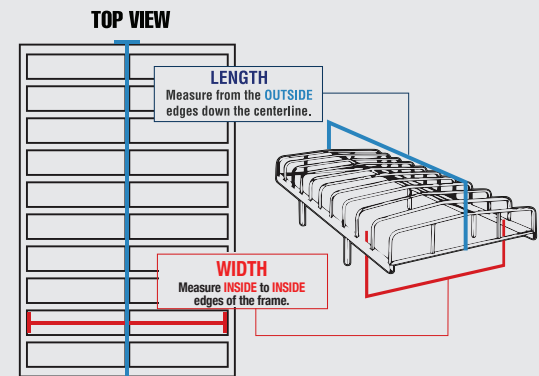

Brands above are in no way associated with the products of Great Lakes Marine.

VINYL CANOPY COLORS

Black BLACK TRIM	Gray BLACK TRIM	Beige BROWN TRIM	Blue WHITE TRIM	Green BLACK TRIM	Yellow WHITE TRIM	White WHITE TRIM
---------------------	--------------------	---------------------	--------------------	---------------------	----------------------	---------------------

View larger swatches and color codes on page 74.

DEFENDER FABRIC CANOPY COLORS

Burgundy WHITE TRIM	Midnight BLACK TRIM	Dubonnet Tweed BLACK TRIM	Cadet BLACK TRIM	Pacific WHITE TRIM	Linen Tweed BLACK TRIM	Charcoal Tweed BLACK TRIM	Forest BLACK TRIM	Toast BROWN TRIM	Navy WHITE TRIM	Hemlock Tweed BLACK TRIM
------------------------	------------------------	------------------------------	---------------------	-----------------------	---------------------------	------------------------------	----------------------	---------------------	--------------------	-----------------------------



All canopy orders include toggle cords for installation.

SHORE STATION REPLACEMENT CANOPY



part#	Defender	Vinyl	Size/Color
part#	CSSD-	CSSV-	13x52???
part#	CSSD-	CSSV-	13x62???
part#	CSSD-	CSSV-	20x88???
part#	CSSD-	CSSV-	21x985???
part#	CSSD-	CSSV-	23x985???
part#	CSSD-	CSSV-	18x100???
part#	CSSD-	CSSV-	20x100???
part#	CSSD-	CSSV-	22x100???
part#	CSSD-	CSSV-	13x108???
part#	CSSD-	CSSV-	22x108???
part#	CSSD-	CSSV-	24x108???
part#	CSSD-	CSSV-	26x108???
part#	CSSD-	CSSV-	22x120???
part#	CSSD-	CSSV-	24x120???
part#	CSSD-	CSSV-	26x120???
part#	CSSD-	CSSV-	30x120???
part#	CSSD-	CSSV-	26x132???
part#	CSSD-	CSSV-	30x132???
part#	CSSD-	CSSV-	34x132???
part#	CSSD-	CSSV-	36x144???

MEASURING INSTRUCTIONS

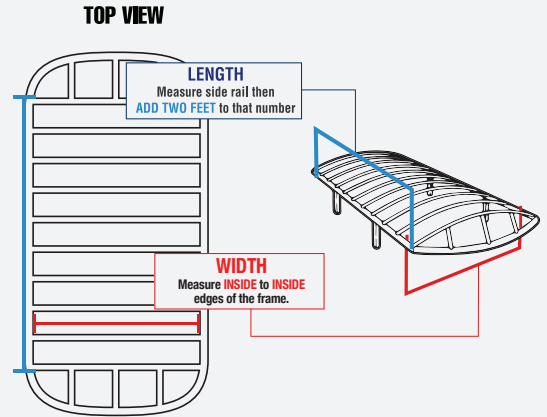

SUNSTREAM REPLACEMENT CANOPY (DELUXE PEAK ROOF)

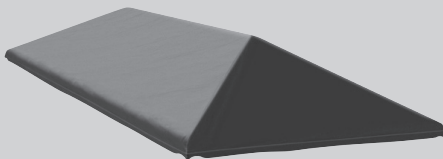

part#	Defender	Vinyl	Size/Color
part#	CSTD-	CSTV-	22x108???
part#	CSTD-	CSTV-	24x108???
part#	CSTD-	CSTV-	27x108???
part#	CSTD-	CSTV-	24x114???
part#	CSTD-	CSTV-	27x114???
part#	CSTD-	CSTV-	27x126???
part#	CSTD-	CSTV-	30x126???
part#	CSTD-	CSTV-	36x126???
part#	CSTD-	CSTV-	42x126???

MEASURING INSTRUCTIONS

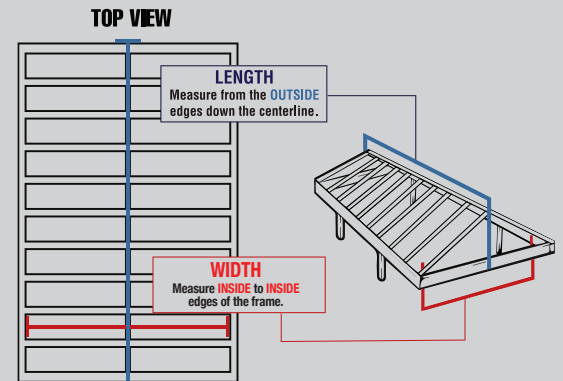

Brands above are in no way associated with the products of Great Lakes Marine.



# REPLACEMENT CANOPIES

## TRITON REPLACEMENT CANOPY



part#	Defender	Vinyl	Size/Color
	CTR- CTR-	CTR-	23x120???

## MEASURING INSTRUCTIONS

### TOP VIEW

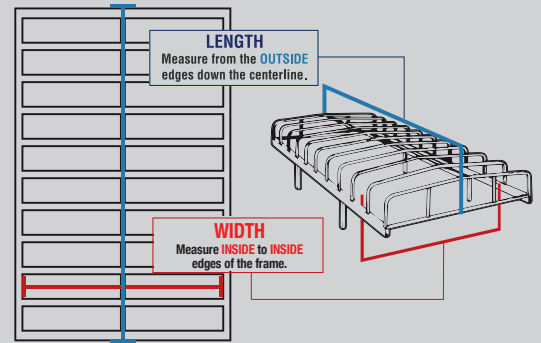

## VIBO REPLACEMENT CANOPY



part#	Defender	Vinyl	Size/Color
	CVBD-	CVBV-	20x96???
	CVBD-	CVBV-	22x96???
	CVBD-	CVBV-	22x108???
	CVBD-	CVBV-	24x108???
	CVBD-	CVBV-	26x108???
	CVBD-	CVBV-	22x114???
	CVBD-	CVBV-	24x114???
	CVBD-	CVBV-	26x114???
	CVBD-	CVBV-	28x114???

## MEASURING INSTRUCTIONS

### TOP VIEW

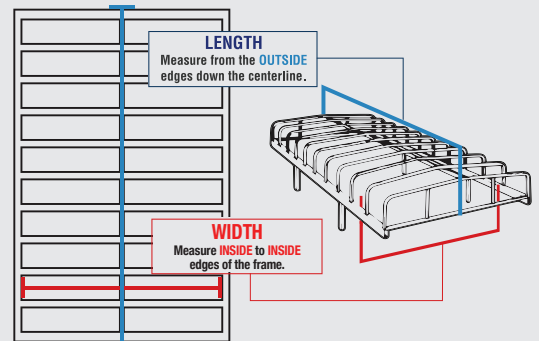

Brands above are in no way associated with the products of Great Lakes Marine.



VINYL CANOPY COLORS

<b>Black</b>	<b>Gray</b>	<b>Beige</b>	<b>Blue</b>	<b>Green</b>	<b>Yellow</b>	<b>White</b>
BLACK TRIM	BLACK TRIM	BROWN TRIM	WHITE TRIM	BLACK TRIM	WHITE TRIM	WHITE TRIM

View larger swatches and color codes on page 74.

DEFENDER FABRIC CANOPY COLORS

<b>Burgundy</b>	<b>Midnight</b>	<b>Dubonnet Tweed</b>	<b>Cadet</b>	<b>Pacific</b>	<b>Linen Tweed</b>	<b>Charcoal Tweed</b>	<b>Forest</b>	<b>Toast</b>	<b>Navy</b>	<b>Hemlock Tweed</b>
WHITE TRIM	BLACK TRIM	BLACK TRIM	BLACK TRIM	WHITE TRIM	BLACK TRIM	BLACK TRIM	BLACK TRIM	BROWN TRIM	WHITE TRIM	BLACK TRIM



All canopy orders include toggle cords for installation.





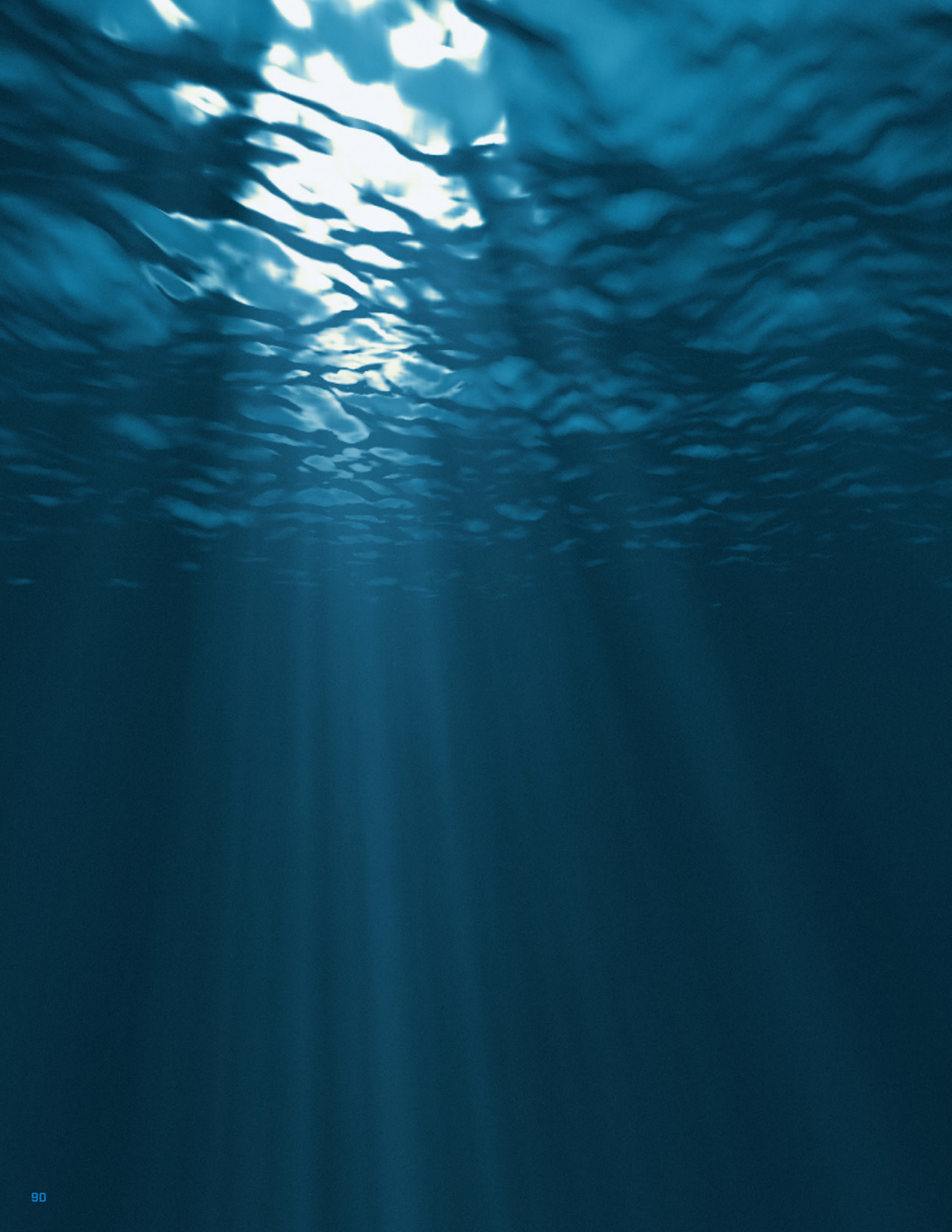





**Great Lakes Marine Products  
709 Old Hwy 14  
P.O. Box 111  
Nicollet, MN 56074**

**Weekdays, 7:30 am to 4:30 pm CST**

**Ph: 800-541-9860  
Fax: 507-225-3053  
[www.glmarineproducts.com](http://www.glmarineproducts.com)**





## MARINE BUMPERS & ACCESSORIES

**800-541-9860**  
**[www.glmarineproducts.com](http://www.glmarineproducts.com)**